

1-1-2005

Experimental Study On The Effects Of Operational Parameters Of A Downdraft Gasifier

Lin Wei

Follow this and additional works at: <https://scholarsjunction.msstate.edu/td>

Recommended Citation

Wei, Lin, "Experimental Study On The Effects Of Operational Parameters Of A Downdraft Gasifier" (2005).
Theses and Dissertations. 2150.
<https://scholarsjunction.msstate.edu/td/2150>

This Graduate Thesis - Open Access is brought to you for free and open access by the Theses and Dissertations at Scholars Junction. It has been accepted for inclusion in Theses and Dissertations by an authorized administrator of Scholars Junction. For more information, please contact scholcomm@msstate.libanswers.com.

EXPERIMENTAL STUDY ON THE EFFECTS OF OPERATIONAL PARAMETERS
OF A DOWNDRAFT GASIFIER

By
Lin Wei

A Thesis
Submitted to the Faculty of
Mississippi State University
in Partial Fulfillment of the Requirements
for the Degree of Master of Science
in Biological Engineering
in the Department of Agricultural and Biological Engineering

Mississippi State, Mississippi

December 2005

EXPERIMENTAL STUDY ON THE EFFECTS OF OPERATIONAL PARAMETERS
OF A DOWNDRAFT GASIFIER

By
Lin Wei

Approved:

Dr. J. Alex Thomasson
Professor of Biological and Agricultural
Engineering, Texas A&M University
(Director of Thesis)

Dr. R. Mark Bricka
Associate Professor of Chemical
Engineering
(Co-Director of Thesis)

Dr. Ruixiu Sui
Assistant Research Professor of
Agricultural and Biological Engineering
(Committee Member)

Dr. Sandun D. Fernando
Assistant Professor of Agricultural and
Biological Engineering
(Committee Member)

Dr. William D. Batchelor
Graduate Coordinator of the Department
of Agricultural and Biological
Engineering

Dr. Kirk H. Schulz
Dean of the Bagley College of
Engineering

Name: Lin Wei

Date of Degree: December 9, 2005

Institution: Mississippi State University

Major Field: Biological Engineering

Major Professor: Dr. J. Alex Thomasson

Co-Major Professor: Dr. R. Mark Bricka

Title of Study: EXPERIMENTAL STUDY ON THE EFFECTS OF
OPERATIONAL PARAMETERS OF A DOWNDRAFT GASIFIER

Pages in Study: 164

Candidate for Degree of Master of Science of Biological Engineering

To examine the effects of operational parameters on syn-gas quality and bio-fuel conversion rate under various running conditions, an experimental study of hardwood chip's gasification in a downdraft gasifier was conducted. The resulting syn-gas had average low heating value of 5.79 ± 0.52 MJ/ Nm³, tar concentration of 14.06 ± 8.54 mg/Nm³, particulate concentration of 3.05 ± 1.79 mg/Nm³, hardwood conversion rate of 2.37 ± 0.24 Nm³/kg, and carbon conversion rate of $98.01 \pm 0.53\%$. This syn-gas is of acceptable quality to be used as a fuel source for internal combustion engine operations. The gasifier's grate temperature had no evident effects on syn-gas quality and conversion rate within a range of 740 to 817°C. The particulate contents in pre-filtered syn-gas significantly increased when the gas flow rate changed from 36 to 56 Nm³/h. When the moisture content of hardwood chips increased, tar content of post-filtered syn-gas significantly increased, and CO content significantly decreased.

ACKNOWLEDGMENTS

I wish to express my sincere gratitude to the many people without whose selfless assistance this thesis could not have been completed. First of all, sincere thanks are due to my major advisor, Dr. J. Alex Thomasson, and co-advisor, Dr. R. Mark Bricka, for their magnanimities in efforts to guide and assist me throughout the intricacies of the masters program. They have helped me in every possible way: lecturing my courses, participating in the experimental tests, proofreading the thesis and improving its quality both scientifically and editorially, and offering financial support. This thesis would have been inconceivable without their support, guidance, and encouragement. Expressed appreciation is also due to the other members of my dissertation committee, namely, Dr. Ruixiu Sui, and Dr. Sandun D. Fernando, for the invaluable aid and direction provided by them. In addition, I wish to thank to Dr. Dongfeng Wu and Dr. Janice DuBien for their help in statistical experimental design and analysis of resulting data.

Special thanks are due to Mr. Eugene P. Columbus, Mr. James R. Wooten, Mr. Daniel Chesser, and Mr. Prashanth R. Buchireddy for their help in modification of the gasifier system, material preparations and experimental runs. Without their support, this study would have not been completed.

I would also like to thank Community Power Corporation (CPC) for their guidance in gasifier system installation and operation, and Weyerhaeuser Timber Company for their donation of experimental materials.

Finally, I deeply appreciate my wife, Haixian, and daughter, Ena, for their consistent backing and encouragement, which have been a steady source of peace, pleasure, and inspiration.

TABLE OF CONTENTS

	Page
ACKNOWLEDGMENTS.....	ii
LIST OF TABLES	vi
LIST OF FIGURES.....	ix
LIST OF PHOTOGRAPHS	xii
LIST OF ACRONYMS AND ABBREVIATIONS	xiii
CHAPTER	
I. INTRODUCTION	1
1.1 Background	1
1.2 Objectives of Study	4
II. OVERVIEW OF GASIFIERS.....	6
2.1 Overview of Gasifier Development History.....	6
2.2 Biomass Gasification Principle	8
2.2.1 Drying	8
2.2.2 Pyrolysis	9
2.2.3 Oxidation	10
2.2.4 Reduction.....	11
2.3 Gasifier Types	12
2.3.1 Fix-bed Gasifier	13
2.3.1.1 Updraft Gasifier.....	13
2.3.1.2 Downdraft Gasifier	14
2.3.2 Fluidized-bed Gasifier	16
2.4 Gasifier Selection	18
2.5 Previous Investigations	19
2.6 Biomass Resources for Gasification.....	22
III. SYN-GAS QUALITY	29
3.1 Syn-gas Quality	29
3.1.1 Syn-gas Composition	29
3.1.2 Impurities in Syn-gas	31
3.1.3 Biomass Conversion Rate	33
3.2 Syn-gas Quality for Internal Combustion Engine Use	34
IV. MATERIALS AND METHODS	35
4.1 Overview to Technical Approach.....	35
4.2 Material Description and Preparation.....	36

CHAPTER	Page
4.3 Gasifier System Operation	37
4.3.1 Feeder Unit	37
4.3.2 Gasifier Unit	38
4.3.3 Separating and Cooling Unit.....	40
4.3.4 Filter Cleaning Unit	41
4.3.5 Gas Flare.....	41
4.3.6 Control System	41
4.4 Experimental Design	44
4.5 Data Acquisition Systems	49
4.5.1 Automatic Data Acquisition System.....	49
4.5.2 Syn-gas Composition Measurement System.....	50
4.5.3 Tar and Particulate Analysis	51
4.5.3.1 Syn-gas sampling for tar and particulate analysis	51
4.5.3.2 Particulate analysis	52
4.5.3.3 Tar analysis.....	53
4.5.4 Bio-fuel Moisture Content Measurement System.....	54
4.5.5 Conversion Rate Measurement	55
V. RESULTS AND DISCUSSION.....	69
5.1 RFGG System Operation Analysis.....	69
5.1.1 Feed Unit Operation.....	69
5.1.2 Gasification Chamber Control Operation	70
5.1.3 Syn-gas Separating and Cooling Unit Operation	74
5.1.4 Syn-gas Cleaning Unit Operation	74
5.2 Experimental Results Summary	75
5.3 Syn-gas Evaluation.....	81
5.4 Biomass Conversion Rate Analysis	83
5.5 Analysis of Operational Parameter Effects	84
5.5.1 Effects of Grate Temperature.....	86
5.5.2 Effects of Gas Flow Rate	88
5.5.3 Effects of Moisture Contents of Hardwood Chips.....	90
5.6 Data Quality and Error Estimation	93
VI. CONCLUSIONS AND RECOMMENDATIONS.....	110
6.1 Summary and Conclusions.....	110
6.2 Suggestions for Future Research.....	111
REFERENCES.....	113
APPENDIX	
A. PROCEDURE FOR TAR AND PARTICULATE DETERMINATIONS	117
B. A TYPICAL DATAGRAPH RECORD FOR HARDWOOD CHIP GASIFICATION.....	131
C. ONE WAY ANOVA FOR THE EFFECTS OF GAS FLOW RATES	135
D. ONE WAY ANOVA FOR THE EFFECTS OF MOISTURE CONTENTS.....	149

LIST OF TABLES

TABLE	Page
3-1 Acceptable Syn-gas Quality for ICE Operation.....	34
4-1 Properties of Hardwood Chips (Dry Matter)	37
4-2 Independent Variable Levels.....	47
4-3 Experimental Treatment Combinations	48
4-4 Randomized Experimental Running Order	48
4-5 List of Automatically Measuring Variables in the Gasifier System	50
5-1 Randomized Experimental Running Order for Supplemental Test Runs.....	76
5-2 Summary of Actual Running Conditions and Setting Conditions.....	77
5-3 Summary of Low Heating Value and Compositions of Syn-gas.....	78
5-4 Summary of Tar and Particulate Contents in Pre- and Post-filter Syn-gas	79
5-5 Summary of Feeding Rate, Conversion Rate, Carbon Conversion Rate, and Residue Rate	80
5-6 Average Syn-gas Properties for Overall Test Runs.....	82
5-7 Comparison of Syn-gas Quality with Published and Tested Data.....	82
5-8 Comparison of Particulate and Tar Content Representative Ranges for Different Type Gasifiers.....	83
5-9 Comparison of Requirements of Engine Use and Test Data.....	83

TABLE	Page
5-10 Statistical Analysis for the Effects of Gas Flow Rate ($\alpha = 0.05$)	90
5-11 Statistical Analysis for the Effects of Moisture Content ($\alpha = 0.05$).....	93
C1 Compositions and Low Heating Values at Different Gas Flow Rates	136
C2 Feeding Rates, Conversion Rates, and Residue Rates at Different Gas Flow Rates	137
C3 Tar and Particulate Concentrations at Different Gas Flow Rates.....	137
C4 SAS Program for Analyzing the Effects of Gas Flow Rates	138
C5 ANOVA for Particulates in Pre-filtered Syn-gas at Different Gas Flow Rates.....	139
C6 ANOVA for Tars in Pre-filtered Syn-gas at Different Gas Flow Rates.....	140
C7 ANOVA for Tars in Post-filtered Syn-gas at Different Gas Flow Rates.....	141
C8 ANOVA for Particulates in Post-filtered Syn-gas at Different Gas Flow Rates...	142
C9 ANOVA for Low Heating Values of Post-filtered Syn-gas at Different Gas Flow Rates	143
C10 ANOVA for CH ₄ in Post-filtered Syn-gas at Different Gas Flow Rates	144
C11 ANOVA for CO in Post-filtered Syn-gas at Different Gas Flow Rates.....	145
C12 ANOVA for CO ₂ in Post-filtered Syn-gas at Different Gas Flow Rates	146
C13 ANOVA for H ₂ in Post-filtered Syn-gas at Different Gas Flow Rates	147
C14 ANOVA for Conversion Rates at Different Gas Flow Rates	148
D1 Compositions and Low Heating Values at Different Moisture Contents.....	150
D2 Tars and Particulates in Syn-gas at Different Moisture Contents.....	151
D3 Feeding Rate, Conversion Rate, and Residue Rate at Different	152
D4 SAS Program for Analyzing the Effects of Moisture Content.....	153

TABLE	Page
D5 ANOVA for Low Heating Values of Syn-gas at Different Moisture Contents.....	154
D6 ANOVA for CO in Syn-gas at Different Moisture Contents	155
D7 ANOVA for CH ₄ in Syn-gas at Different Moisture Contents.....	156
D8 ANOVA for H ₂ in Syn-gas at Different Moisture Contents.....	157
D9 ANOVA for CO ₂ in Syn-gas at Different Moisture Contents.....	158
D10 ANOVA for Conversion Rates at Different Moisture Contents.....	159
D11 ANOVA for Tars in Pre-filtered Syn-gas at Different Moisture Contents.....	160
D12 ANOVA for Particulates in Pre-filtered Syn-gas at Different Moisture Contents.....	161
D13 ANOVA for Tars in Post-filtered Syn-gas at Different Moisture Contents.....	162
D14 ANOVA for Particulates in Post-filtered Syn-gas at Different Moisture Contents.....	163
D15 ANOVA for Residue Rates at Different Moisture Contents	164

LIST OF FIGURES

FIGURE	Page
2-1 Types of Gasifier	25
2-2 Fixed-bed Updraft Gasifier.....	26
2-3 Fixed-bed Downdraft Gasifier	26
2-4 Bubbling-Bed Gasifier.....	27
2-5 Circulating-Bed Gasifier	27
2-6 Gasification Temperatures for Different Bio-fuels.....	28
4-1 Flowchart of Hardwood Chip Gasification Study	59
4-2 Flowchart of Gasification Process in the Gasifier System.....	60
4-3 Structure and Principle of Gasifier Unit	60
4-4 Relationships between Independent and Dependent Variables.....	61
4-5 Locations of Measuring Sensors in the Gasifier System.....	61
4-6 Positions of Thermocouples in Gasification Chamber of the Gasifier	62
4-7 Reactor Temperature Profile of the Gasifier System	62
4-8 Flowchart of Syn-gas Composition Measurement System.....	63
4-9 Flowchart of Syn-gas Sampling.....	63

FIGURE	Page
4-10 Flowchart of Near Inferred Moisture Content Measurement System	64
5-1 Fluctuations of Gasifier Temperatures During A Typical Run.....	96
5-2 Comparison of Setting and Actual Grate Temperatures.....	96
5-3 Temperature Profiles at Different Setting Grate Temperatures	97
5-4 Comparison of Setting and Actual Gas Flow Rates	97
5-5 Gas Flow Rate of A Typical Test Run	98
5-6 Syn-gas Temperatures in Bag Filter of A Typical Test Run	98
5-7 Relationships of Independent, Random, and Dependent Variables	99
5-8 Syn-gas Compositions at Different Grate Temperatures.....	99
5-9 Low Heating Values of Syn-gas at Different Grate Temperatures	100
5-10 Conversion Rate of Hardwood Chips at Different Grate Temperatures.....	100
5-11 Tar and Particulate Contents in Pre-filter Syn-gas at Different Grate Temperatures	101
5-12 Tar and Particulate Contents in Post-filter Syn-gas at Different Grate Temperatures	101
5-13 Compositions of Syn-gas at Different Gas Flow Rate.....	102
5-14 Low Heating Values of Syn-gas at Different Gas Flow Rates.....	102
5-15 Conversion Rate of Hardwood Chips at Different Gas Flow Rates	103
5-16 Tar and Particulate Contents in Pre-filter Syn-gas at Different Gas Flow Rates.....	103
5-17 Tar and Particulate Contents in Post-filter Syn-gas at Different Gas Flow Rates.....	104
5-18 Temperature Profiles at Different Gas Flow Rates	104

FIGURE	Page
5-19 Temperature Profiles at Different Moisture Contents	105
5-20 Compositions of Syn-gas at Different Moisture Contents	105
5-21 Low Heating Values of Syn-gas at Different Moisture Contents.....	106
5-22 Conversion Rate of Hardwood Chips at Different Moisture Contents.....	106
5-23 Tar and Particulate Contents in Pre-filter Syn-gas at Different Moisture Contents.....	107
5-24 Tars and Particulate Contents in Post-filter Syn-gas at Different Moisture Contents.....	107
5-25 Time Distribution of Hardwood chip Moisture Content During A Typical Test Run.....	108
A1 Flowchart of Pre-filtered Syn-gas Sampling.....	120
A2 Flowchart of Post-filtered Syn-gas Sampling.....	121
B1 Temperatures of Gasifier During a Typical Test Run.....	132
B2 Bag Filter Temperatures of Gasifier During a Typical Test Run	132
B3 Pressure Drop in Gasifier System During a Typical Test Run.....	133
B4 Gas Flow Resistance in Gasifier During a Typical Test Run.....	133
B5 Gas Flow Rate of Gasifier During a Typical Test Run.....	134

LIST OF PHOTOGRAPHS

PHOTO	Page
4-1 Hardwood Chips for Gasification.....	64
4-2 Overview of the Gasifier System	65
4-3 Screw Feeder of Gasifier System	66
4-4 Belt Conveyor of Gasifier System	66
4-5 Bag Filter of Gasifier System.....	67
4-6 Assembly of Sampling Syn-gas Filter Holder	67
4-7 Near Infrared Detector of Moisture Content Meter	68
5-1 Comparisons of Pre- and Post-filtered Syn-gas Sampling Filter Papers.....	109
5-2 Comparisons of Pre- and Post-filtered Syn-gas Acetone-tar Solutions.....	109

LIST OF ACRONYMS AND ABBREVIATIONS

ANOVA	Analysis of variance
ASTM	American Society for Testing and Materials
$(C_6H_{10}O_5)_n$	Cellulose
CCR	Carbon conversion rate
C _c	Carbon content
C _{cf}	Carbon content in bio-fuel
C _{cs}	Carbon content in syn-gas
CH ₄	Methane
CO	Carbon monoxide
CO ₂	Carbon dioxide
C _p	Concentration of particulates in syn-gas
CPC	Community Power Corporation
CR	Conversion rate of biomass gasification
C _t	Concentration of tar in syn-gas
DOE	Department of Energy
FAO	Food and Agriculture Organization of the United Nations
FR	Feeding Rate
G _{fi}	Actual gas flow rate during running period
H ₂	Hydrogen
H ₂ O	Water
HHV	High Heating Value
ICE	Internal Combustion Engine
L _{CH4}	Low heating value of CH ₄
L _{CO}	Low heating value of CO

L_{H_2}	Low heating value of H_2
LHV	Low Heating Value
MC	Moisture Content
M_{cf}	Moisture content of bio-fuel
MSW	Municipal Solid Waste
M_i	Molar mass of CO , CO_2 , or CH_4
P	Output pressure of syn-gas
R	Gas constant
T	Output temperature of syn-gas
NIR	Near Infrared
NO_x	Nitrogen Oxide
P_{CH_4}	Percentage of CH_4 in syn-gas
P_{CO}	Percentage of CO in syn- gas
P_{H_2}	Percentage of H_2 in syn-gas
RFGG	Renewable Fuel Gas Generator
RDF	Refuse Derived Fuel
RR	Residue Rate
SAS	Statistical Analysis Software (SAS, Inc., Cary, No. Car.)
V_g	Volume of syn-gas
V_{tg}	Total volume of syn-gas
W_a	Weight of ash residue
WB	Wet-basis
WC	Water Column
W_c	Weight of char residue
W_{cs}	Weight of carbon in syn-gas
W_{cf}	Weight of carbon in bio-fuel
W_f	Weight of bio-fuel consumed
W_p	Weight of particulates in syn-gas
W_{rs}	Weight of carbon residues
W_t	Weight of tars in syn-gas

CHAPTER I

INTRODUCTION

1.1 Background

Rapidly developing economies and societies rely heavily on fossil fuels, like coal, oil, and natural gas as sources for energy, fuels, and chemicals. The continued usage of fossil fuels has been associated with serious problems, including resource depletion, environmental pollution, and climate change. It is commonly believed that biomass may offer an alternative to conventional energy sources that could help provide national energy security, economic growth, and environmental benefits. The term "biomass" represents any organic matter that has been originally derived from plants as a result of the photosynthetic conversion process, and not involving the fossilization process. Most common biomasses include forest products and their residues, agricultural crops and their residues, municipal solid wastes, animal manure and aquatic plants and algae.

Gasification is a common way to convert solid biomass materials (also known as bio-fuels) into utilizable gas-phase compounds. The synthesis gas (syn-gas, also known

as producer gas or product gas) produced from biomass gasification can be an important resource for the energy and chemical industries.

The renewed interest in biomass gasification for energy products in the U.S. has increased since the 1970s' energy crisis. Many investigations have indicated that syn-gas can be used as a fuel source for turbines or internal combustion engine (ICE) operations, and can offer an alternative approach for power generation and distribution at small scales. Producing high-quality syn-gas to meet operational requirements of turbines or ICEs is critical to the successful implementation of biomass gasification. Many kinds of gasifiers for producing high-quality syn-gas have therefore been developed. As a result of extensive research efforts, gasification technologies such as bio-fuel pre-treatment and syn-gas generation have become more developed and available at the laboratory or pilot scales. However, producing high-quality syn-gas from biomass gasification still presents the main technological barrier to be overcome. Specifically, the efficient and economic removal of tars and particulates from the syn-gas are the major obstacles (Maniatis, 2001). The downdraft gasifier, a traditional gasifier type, is attractive for its simple and robust construction, simple and reliable operation, suitability with various bio-fuels, high conversion rate (90-99%), and production of relatively clean syn-gas containing low tar and particulate concentrations (Warnecke, 2000; and Tatsiopoulos and Tolis, 2003). Traditional approaches like downdraft gasification combined with modern technologies may overcome the current obstacles for biomass gasification.

The syn-gas produced from biomass gasification consists of mainly carbon monoxide (CO), carbon dioxide (CO₂), hydrogen (H₂), methane (CH₄), water (H₂O), and

nitrogen (N_2), but also contains contaminants small char particulates, ashes, and tars. For energy purposes, the major concerns about syn-gas are its heating value, composition, and possible contamination (tars, particulates, etc.). The heating value (also known as high heating value, HHV) is defined as the amount of heat produced by the complete combustion of a unit quantity of fuel. By subtracting the latent heat of vaporization of the water vapor formed by combustion from the HHV, the low heating value (LHV) is determined. For fueling ICEs, only combustible compounds in the syn-gas like CO, H_2 , and CH_4 are utilizable; the remaining noncombustible compounds are undesirable. Impurities like particulates, tars, and ash are problematic in ICE operations. Using syn-gas containing these impurities can result in undesirable emissions that have a negative environmental impact. Furthermore, particulates may seriously corrode and clog pipelines, injectors and pistons of ICEs or other downstream devices. Tars can also condense in pipe lines, injectors, and filters, resulting in blockages, reducing efficiency or causing failure of the ICE, ultimately resulting in the possible failure of an entire gasification project.

The composition and quantity of syn-gas depend on the bio-fuel's properties, gasifier operating conditions, and the approach used for the gasification process. For a particular gasification system, operating conditions play a very important role in all aspects of biomass gasification. These include carbon conversion, syn-gas composition, tar formation and reduction (Devi et al., 2003). The selections of operating parameters are extremely important for producing high quality syn-gas. For proper selections, one should consider how the yield and the composition of syn-gas vary with operating

parameters, how the tar and particulate contents in syn-gas vary with operating conditions, and how the properties of bio-fuels (e.g. moisture content) affect the gasification process. Providing proper operating parameters to improve the performance of existing gasifiers for producing high-quality syn-gas is an important goal of this study. Producing high-quality syn-gas at the outlet of the gasification system is preferable to producing crude gas, which has to be refined later for most applications. High-quality syn-gas not only eliminates the necessity of downstream cleaning equipment, but also lowers the economic threshold of gasification commercialization.

1.2 Objectives of Study

The purpose of this study is to explore proper biomass conversion approaches for producing high-quality syn-gas. To meet this goal, a biomass gasification facility was installed in 2003 as a cooperative effort between the Agricultural and Biological Engineering and Chemical Engineering Departments at Mississippi State University. This facility consists of mainly a downdraft fixed-bed gasifier system, the Renewable Fuel Gas Generator (RFGG), purchased from Community Power Corporation (CPC), Littleton, Colorado. An experimental study was conducted (1) to examine the operation of this gasifier system, (2) to assess the suitability of syn-gas produced with this system for use as a fuel source for ICEs, and (3) to investigate the relationships among, and the effects of changing, operating parameters of the downdraft gasifier.

In particular, the objectives of this study were to determine the effects of various operating conditions of the RFGG on the following:

- The composition and LHV of syn-gas

- The tar and particulate concentrations in pre-filter and post-filter syn-gas
- The conversion rate of the bio-fuel

Following this introduction, Chapter 2 presents an overview of gasifier principles, bio-fuel supplies, and previous work related to this study. Chapter 3 presents several parameters of syn-gas quality and methods to calculate them. A literature survey aimed at determining syn-gas quality requirements for current ICE usage is also presented. These requirements are compared with the actual syn-gas quality from the downdraft gasifier in this study and act as a guideline in the evaluation of suitability of the syn-gas for fueling ICEs. Chapter 4 describes the methods and materials used in this study, and chapter 5 presents the results and discussion of the experiments. Finally, the conclusions and suggestions for future work can be found in Chapter 6.

CHAPTER II

OVERVIEW OF GASIFIERS

2.1 Overview of Gasifier Development History

Biomass gasification is a technology having a greater than one hundred year old history. This technology has undergone four development stages. The first stage was from 1840 to 1900, the “Initial Commercialization Period”. The first commercially used gasifier was built in France in 1840, and then successfully used with engines for power generation in 1878. A gas industry was established gradually for gaslights, internal combustion engines, and transportation in Europe at the end of 19th century. The second stage was from 1900 to 1950, the “Flourishing Period”. During this period, many gasifier-engine systems were sold and used for power and electrical generation. Syn-gas was also used to fuel trucks and tractors, and was widely used in the transportation system when petroleum was too expensive or scarce in Europe. When petroleum was used to support the military during World War II, over a million gasifiers were built and used by the civilian sector in Germany. The major bio-fuel used for gasification at that time was wood. The third stage in gasification history was from 1950 to 1970, the “Forgotten Period”. After the end of World War II, the plentiful supply of gasoline and

diesel were available at a cheap cost resulting in gasification technologies' being abandoned and losing glory and importance. During these decades, gasification became a "Forgotten Technology" due to its low efficiency, high cost, and inconvenient operation. The fourth stage has been from 1970 to the present, the "Renewed Development" stage. The energy crisis and environmental concerns sparked a renewed interest in biomass gasification technologies for power generation (Turare, 1997). Since then, various innovative gasifiers have been developed, also many biomass species other than wood have been tried for gasification, such as forest residues, wood wastes (e.g., sawdust and mechanically shredded or ground wood chips), short rotation energy crops (e.g., willow and switchgrass), agricultural crops and their residues, wastes of food processing, waste sludge from the pulp and paper industry, some municipal solid wastes, animal manure, and aquatic plants and algae (Li, 2002). The progress in gasification has made this technology more efficient, environmentally acceptable, and convenient to use, and has lower cost. Great potential has been foreseen in gasification for energy and chemical production.

According to studies conducted by Shell International Petroleum Company and the Intergovernmental Panel on Climate Change, biomass could satisfy between one-quarter and one-half of the world's demand for energy by the middle of the 21st century (DOE, 2004). In fact, biomass has become the fourth largest energy resource after coal, oil, and natural gas, supplying about 14% of global energy. Installed capacity of biomass power generation worldwide was reported at approximately 35,000 MW at the beginning of the 21st century (Tsamba, 2001). In the U.S., biomass power reached 7,000 MW

(mostly in the pulp and paper industry) by 2001. Five hundreds of these facilities generated electricity from wood or wood waste (Grabowski, 2001). The increase in bio-energy appears to be a continuing trend.

2.2 Biomass Gasification Principle

Biomass gasification is basically a thermo-chemical process which converts biomass materials into combustible gases for energy or chemicals. The gasification process involves a number of complex thermo-chemical reactions. Gasifiers can differ in either their system construction or bio-fuels used, but generally not in the chemical reactions. Regardless of gasifier type, the bio-fuels must undergo drying, pyrolysis, oxidation, and reduction steps to convert the fuel from a solid phase into a gas phase. These thermo-chemical processes involved in gasification are presented below.

2.2.1 Drying

The bio-fuels used for gasification typically have moisture contents (MC) ranging from 5 to 50% (Note: all moisture contents mentioned in this report are wet basis). Since solid bio-fuels are introduced into the gasifier as a wet or moist material, drying of the bio-fuels must occur in the first zone as a result of heat transfer from the higher temperature zones of the gasifier. At temperatures above 100°C, water is driven from bio-fuels and converted to steam. Some portion of the bio-fuels is dried in other zones of the reactor. Part of this water vapor may be reduced to hydrogen during gasification, and the rest can end up as moisture in the produced syn-gas. In the drying zone, the bio-fuels do

not experience appreciable decomposition during drying, but consume heat to evaporate water from the bio-fuels.

2.2.2 Pyrolysis

The bio-fuels begin to pyrolyze at temperatures above 200°C. Pyrolysis is the thermal decomposition of bio-fuels in the absence of oxygen at temperatures ranging from 200 to 600°C. For gasification to take place there must always be a low-temperature zone where pyrolysis takes place and condensable hydrocarbons are generated.

Pyrolysis results in the production of three products, solid char, liquid tar, and a mixture of gases. The proportions of these components are influenced by the chemical compositions of bio-fuels being fed and the operating conditions of the gasifier. The temperature of the reactor is critical at this stage. The heating value of the gases produced during the pyrolysis process is relatively low (about 3.5 to 8.9 MJ/Nm³), and the details of these pyrolysis reactions are not well known, but it is understood that the large molecules (such as cellulose, hemi-cellulose and lignin) break down into medium-size molecules and carbon (char) during bio-fuel pyrolysis. If the char and medium size molecules remain in the hot zone long enough, some will break down into even smaller molecules of CO, CO₂, H₂, CH₄, even ethane, or ethylene, etc. If the residence time is too short or the temperature too low, then medium sized molecules can escape and will condense as tars and oils in the lower temperature zone of gasifier. The main process of thermal decomposition of biomass can be represented as follows:

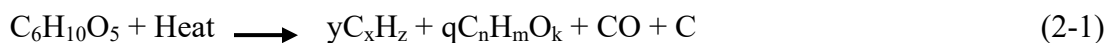

Where: the magnitudes of x , y , z , n , m , k , and q depend on the reaction's temperatures and the residence time of the bio-fuels and their products in the reaction zone.

2.2.3 Oxidation

After pyrolysis, there is an oxidation zone where the pyrolysis products move into the hotter zones of the gasifier. Air is introduced into the oxidation zone under starved oxygen conditions. The air contains, in addition to oxygen and water vapor, inert gases such as nitrogen, which are considered to be non-reactive with fuel constituents at relatively low pressures and temperatures. The oxidation takes place at temperatures ranging from 700 to 1000°C. The principal oxidation reactions are as follows:



Heterogeneous reactions take place between oxygen in the air and the carbon contained in the solid bio-fuel, producing carbon dioxide. Hydrogen in the bio-fuel reacts with oxygen contained in the introduced air, producing steam and heat, and raising the reactor temperatures for drying, pyrolysis, and reduction. Reactions with oxygen are highly exothermic and result in a sharp rise of the temperature up to 1500°C. As mentioned above, an important function of the oxidation zone, apart from heat generation, is to convert and oxidize virtually all condensable products generated in the

pyrolysis zone. Medium-size molecules in this zone like tars and oils are cracked into smaller molecules such as CO, H₂, CH₄, etc.

2.2.4 Reduction

The reaction products of the oxidation zone, hot gases and glowing char, move continually into the reduction zone. Since there is insufficient oxygen in this high temperature zone for oxidation, a number of reduction reactions take place between the hot gases (CO, H₂O, CO₂, and H₂) and char. The principal reduction reactions are as follows:

Carbon dioxide reaction



Water-gas reaction



Water gas shift reaction

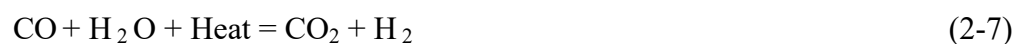

In this zone, the sensible heat of the gases and char is converted as much as possible into the stored chemical energy in the syn-gas, since heat is required during the reduction process. Hence, the temperature of the gases is reduced during this stage. If complete gasification takes place, all the carbon is oxidized or reduced to carbon monoxide, a combustible gas, and some of the mineral matter in the bio-fuels is vaporized. Typically, the remains are ash (solid noncombustible mineral matter) and some char (unburned carbon) (FAO, 1986; Tsamba, 2001; and Turare, 1997).

Biomass gasification is a starved (partial) combustion process that partially oxidizes biomass into a still-combustible mixture of gases. Types and quantities of reactions depend on the temperatures of the reactor and the oxidants used. Air, steam, and oxygen are common oxidants use for biomass gasification. According to the oxidant species used in biomass oxidation, gasification can be further classified into categories: air gasification (the most common way of gasifying solid bio-fuels), pure oxygen gasification, and steam gasification. The distinctions among these categories in terms of output syn-gas are in the LHV level and composition. When biomass is gasified with air, the resulting syn-gas has about 50% nitrogen content and LHV around 2.5 to 8.0 MJ/Nm³. Gasification with pure oxygen results in a high-quality mixture of carbon monoxide and hydrogen, and virtually free of nitrogen. The LHV in this case can range from 10 to 20 MJ/Nm³ (Stevens, 2001).

2.3 Gasifier Types

Currently, the two main gasifier types used for biomass gasification are fixed-bed and fluidized-bed reactors. While these gasifiers differ in system construction or possibly in bio-fuels used, the chemistry of gasification is the same for both gasifier types. However, there are four distinct zones in the reaction chamber of fixed-bed gasifiers relating to the four gasification steps described earlier, whereas this is not the case in fluidized-bed gasifiers. This aspect is the largest dissimilarity between the two types.

Determining which type of gasifier to use depends on the species and the properties of bio-fuels available, the scale of the gasification system, and the end uses of

the syn-gas to be produced. Maniatis (2001) and Knoef (2000) investigated 50 gasifier manufacturers in Europe and North America and found that, of currently offered gasifiers, 75% are the downdraft type, 20% are fluidized-bed, 2.5% are updraft and 2.5% are of other designs (Figure 2-1). Characteristics and principles of these gasifiers are presented in the following sections.

2.3.1 Fix-bed Gasifier

Fixed-bed gasifiers typically have a grate to support the gasifying bio-fuels and maintain a stationary reaction bed. They are relatively easy to design and operate, but have limited capacity. Therefore, fixed-bed gasifiers are preferred for small- to medium-scale applications with thermal requirements up to 1 MW (Klein, 2002). Based on the method of air introduction, fixed-bed gasifiers can be further classified into two primary types: updraft (also known as counter-flow) and downdraft (also known as co-current flow).

2.3.1.1 Updraft Gasifier

The basic structure of an updraft (“counter-flow”) gasifier is shown as Figure 2-2. Here, the bio-fuels enter the top of the reaction chamber while air (or steam, or oxygen in some cases) enters from below the grate. The bio-fuels flow downward and the upward flowing hot gases dry the bio-fuels. The lower the bio-fuels go in the chamber, the higher the temperatures they have. These bio-fuels undergo the four steps of gasification, and are converted into three products, syn-gas, char residues, and ash residues. The syn-gas exits from the top of the chamber, while the chars and the ashes fall through the grate.

The tars and volatiles produced during this process are carried in the exiting syn-gas stream.

The major advantages of updraft gasifiers include the following: (a) a simple gasifier structure, (b) high char oxidation rate, (c) high internal heat exchange between the downward flowing bio-fuels and the upward flowing hot gases, leading to low syn-gas exit temperatures and high equipment efficiency, and (d) the possibility of operation with many types of bio-fuels (sawdust, cereal hulls, etc.) The updraft design can handle bio-fuels with high ash and moisture contents since air is blown through the grate to remove the ash or char residues that may clog the reaction bed. However, a major drawback of updraft gasifiers is that the syn-gas contains high levels of volatile oils (tars), making it unsuitable to be directly used in gas engines or turbines. Furthermore, there are problems associated with the treatment of tars. These problems are of minor importance if the syn-gas is directly combusted for heat, in which case the tars are simply combusted with the syn-gas. There are other means of addressing tar problems, but the treatments may create their own problems. For example, the use of charcoal as fuel to yield low-tar syn-gas involves a loss of energy in the conversion of wood to charcoal and thus is an inefficient use of wood resources. The use of cleaning systems to remove the tars in syn-gas involves difficult waste disposal problems (FAO, 1986).

2.3.1.2 Downdraft Gasifier

In a fixed-bed downdraft gasifier, bio-fuels are also fed at the top of gasifier, but air is introduced at or above the oxidation zone and drawn down through the bio-fuels.

After these bio-fuels are gasified, the produced syn-gas is taken off from the bottom of the gasification bed, and the produced char and ash residues also fall through the grate. The bio-fuels and air move in the same direction, as schematically shown in Figure 2-3, so this type is also called a co-current flow gasifier. As the products of bio-fuel pyrolysis (tars, oils, char and gases) move downward through the reaction bed, they pass through high temperature oxidation and reduction zones, where these products are reduced and converted into the stable gases (CO , CH_4 , CO_2 , H_2 or H_2O). This reduction process reduces the tar contents within the stream of syn-gas exiting in the system. The degree of tar reduction depends on the temperatures of these hot zones and the residence time of the mixture of tars, oils, chars, and gases in the hot zones. A more or less complete breakdown of the tars can be achieved by controlling the temperature and residence time.

Thus, a great advantage of downdraft gasifiers is the possibility of producing a low-tar syn-gas that can be directly used as fuel source for gas turbines or engine operations. The syn-gas containing low tars is easier to fully combust in engines, and so the emissions of the engines are less harmful. Thus, downdraft gasifiers tend to have fewer negative environmental impacts than updraft gasifiers. Moreover, downdraft gasifiers are relatively simple to build and operate, making them easy to alter and study for different purposes.

Downdraft gasifiers also have some drawbacks, such as difficulties in handling bio-fuels with high moisture and/or ash contents. For example, the grate of a downdraft gasifier can be easily clogged by a bio-fuel with high ash content. Furthermore, fluffy, low density materials give rise to flow problems and excessive pressure drop since the

movement of bio-fuels in the gasifier relies on gravity. Therefore, these types of solid bio-fuels must be densified (e.g., pelletized) before use. As compared to updraft, downdraft gasifiers have somewhat lower efficiency resulting from the lower internal heat exchange, and they produce syn-gas of lower heating value. In addition to these drawbacks, it is necessary for downdraft gasifiers to maintain uniform high temperatures over a given cross-sectional area in the reaction chamber. Taken together, these requirements typically limit the use of downdraft gasifiers to a power range of less than 1 MW (Turare. 1997; FAO, 1986; Warnecke, 2000; and Maniatis, 2001).

2.3.2 Fluidized-bed Gasifier

In fluidized-bed gasifiers, bio-fuels, having been reduced to a specified particle size, are fed at the bottom of the reaction chamber. Air is blown through a hot bed of inert granular solid material such as sand or ceramic at a sufficient velocity to keep these particles in a suspended state. Injection of high-velocity air from below forces the gasifying bio-fuels upward through the bed of heated particles to create turbulence, resulting in a mixture resembling a boiling liquid, which distributes and suspends the bio-fuels. The bio-fuel particles are very quickly mixed with the hot bed materials and nearly instantaneously heated up to the temperature to combust, thus maintaining an isotropic temperature for the reactor.

During this process, the bio-fuels are dried and pyrolyzed very quickly, resulting in a component mix with a relatively large amount of gaseous materials. Further gasification and tar conversion reactions occur in the gas phase. The processes of

pyrolysis and char conversion occur throughout the bed. Ash particles are also carried out through the top of the reactor and are removed from the gas stream. The suspended ash and char particles are known as “fly-ash”. Most systems are equipped with an internal cyclone in order to minimize the amount of fly-ash carried downstream. The fluidized-bed design increases heat transfer between bio-fuels and air and bed materials, and allows operating temperatures below 900°C, helping to reduce nitrogen oxide (NO_x) emissions.

The fluidized-bed design has many benefits. First, there are no apparent scale-up limitations (though size may be limited by availability of bio-fuels or local energy demand). The gasifying agent is usually air, supplied at atmospheric pressure, but pressurized gasification can be advantageous when supplying gas turbines larger than 100 MW. Second, Fluidized-bed gasifiers can handle bio-fuels with high ash and/or moisture contents. Third, the danger of ash agglomeration is low because of the relatively low operating temperature (about 850°C). The melting or fusion points of most ashes are above 850°C. Finally, the ability of fluidized-bed gasifiers to deal with fluffy and fine-grained materials (like sawdust, etc.) without the need of pre-processing can be very important.

Major drawbacks of the fluidized-bed gasifier are that the resulting syn-gas has relatively high tar content (up to 500 mg/Nm³), incomplete carbon combustion, and poor response to load changes. If the syn-gas is fed to an ICE, an efficient clean-up system is essential. Because of the amount of clean-up equipment required, very small scale fluidized-bed gasifiers are not recommended. The application range of this type gasifier is generally above 500 kW. Although fluidized-bed gasifiers can handle a wider range of

bio-fuels, the bio-fuel particles typically must be less than 100 mm (about 4 in.) in length, and the moisture content no more than 50%. Problems with feeding, instability of the reaction bed, and fly-ash sintering in the gas channels can occur with some bio-fuels (FAO, 1986; Van Den Aarsen, et al, 1982; and Maniatis 2001).

The two typical types of fluidized-bed gasifiers are bubbling fluidized-bed (BFB) and circulating fluidized-bed (CFB), shown as Figures 2-4 and 2-5. They are distinct in that the circulating type separates and recycles fly-ash from the reaction bed while the bubbling type does not. Fluidized-bed gasifiers have been the focus of appreciable research and development for large scale power generation. Many (semi-) commercial fluidized-bed gasifier applications have been seen in Europe and the U.S. over the last decades; for example, a 15-MW CFB project at McNeil power station at Burlington (Vermont, USA) a 5-MW BFB project at Paia (Hawaii, USA), a 15-MW BFB pilot plant of Enviropower Inc. in Tampere (Finland), a 27-MW CFB power plant at Pöls (Austria), a 10.9-MW CFB “Energy Farm” project at Pisa (Italy), and a 100-MW CFB power plant at Rüdersdorf (Germany) (Klein, 2002; and Spliethoff, 2001).

2.4 Gasifier Selection

Considering the aforementioned gasifier characteristics, downdraft gasifiers are preferable for ICE applications. They produce low-tar syn-gas, require lower capital investments, and can be used where a biomass source has a decentralized supply or in rural areas. Based on the following immediate reasons, a downdraft gasifier system was selected for this study:

- “turn-key” downdraft systems are available, and so little time is required in designing systems
- there is a low requirement for gas clean-up
- the downdraft gasifier operation tends to be relatively stable and simple
- there are potential decentralized sources of abundant forest and/or agricultural residues
- fewer problems occur with the operation of a downdraft gasifier system

2.5 Previous Investigations

Most gasifier development work has been carried out with common fuels such as coal and wood. It has been recognized that bio-fuel properties such as surface area, size, and shape, as well as moisture content, volatile matter and carbon content influence gasification (Turare, 1997). Theoretically, almost all biomass with moisture contents from 5 to 50% can be gasified. Realistically however, gasification becomes difficult when moisture contents of bio-fuels are high.

Gasification system selection and operation are also critical to success in biomass gasification (Devi et al., 2003). It is generally known that gasification produces three main products: syn-gas, char or ash, and oils or tars. The proportions of these products depend on gasifier type, process parameters and chemical composition of biomass (Nader and Padban, 2001), and the composition of these three major reaction products varies under different operational conditions (Deglise and Magne, 1987). Many investigations have indicated that operating parameters of gasifiers strongly affect the quality of syn-gas. Typically, an increase in temperature leads to higher syn-gas production and lower ash fraction. Increasing the residence time of the volatile phase results in increasing syn-

gas yield, but after a certain point this increase is reduced. Chen et al. (2003a) also found that syn-gas yield is strongly influenced by the temperatures in the gasifier, the mechanical or chemical pretreatment of the bio-fuel, and the geometrical configuration of the gasifier. The formation of tars during gasification has been reported to decrease with an increasing air ratio (the ratio of actual air supply to stoichiometric air requirement for complete combustion) (Narvaez et al., 1996; Eurkela and Stahlberg, 1992; and Gil and Corella, 1999). Increasing reaction bed temperature (Narvaez et al., 1996) was found to reduce the amount of tars in syn-gas.

It has been reported that the most important parameters affecting the pyrolysis process with biomass are temperature, residence time, the method of heating bio-fuels, and air supply (Babu and Chaurasia, 2003). Though syn-gas composition is influenced by the Equivalence Ratio (ER, defined as the ratio of the actual fuel/air ratio to the stoichiometric fuel/air ratio) and temperatures, the syn-gas's heating value remains almost the same. For ER = 0.20 to 0.28, a reaction temperature range from 800 to 1000°C was recommended for getting higher heat efficiency (Xu et al., 1994). Devi et al. (2003) found that higher ER values in a fixed-bed gasifier result in lower concentrations of H₂ and CO, and higher CO₂, thus decreasing heating values of the syn-gas.

Catalysis has been used as an important approach for improving syn-gas quality (Chen, et al. 2003b). By using lithium fluoride ballast as a catalyst in a gasifier, the total bio-fuel fraction converted to fuel syn-gas increased from 74 to 80%, and heating values ranged from 14.2 to 16.6 MJ/Nm³ (Pletka et al., 2001). To achieve high carbon conversion and relatively clean (low-tar) syn-gas, a high operating temperature (above 800 °C) in the

gasifier is preferred. Devi et al. (2003) and Hallgren (1997) found the typical gasification temperatures for various bio-fuels and the effects of temperature changes are as shown in Figure 2-6.

To maintain uniform heat transfer and avoid cold spots in the oxidation zone of a downdraft gasifier, air inlet velocities and reactor geometry must be well chosen. FAO (1986) suggested two methods that can be employed to obtain an even temperature distribution in a downdraft gasifier:

- Reducing the cross-sectional area at a certain height in the reactor (so called "throat" concept)
- Spreading the air inlet nozzles over the circumference of the reduced cross-sectional area, or using a central air inlet with a suitable distribution device

The MC of bio-fuels is also important for syn-gas quality. Jayah and Aye (2003) found that MC affected the composition, LHV, and even the tar yield of syn-gas. High MC reduces the thermal efficiency since heat is used to drive off the water from bio-fuels, and consequently this energy is not available for the reduction reactions and for converting the thermal energy into chemical bond energy in the syn-gas. Thus, high-MC bio-fuels result in low heating values in syn-gas. In downdraft gasifiers, high MC gives rise to lower temperatures in the reactor, leads to insufficient tar conversion, and thus further affects syn-gas quality. Operational problems in gasifiers occur if the fuel MC is too low or too high (FAO, 1986).

An overview of previous investigations indicates that bio-fuel MC, reactor temperature, and the amount of air (oxidant) introduced into a gasifier have significant effects on syn-gas quality. Generally, the higher the reactor temperature, the lower the tar content in the syn-gas, and the lower the LHV of the syn-gas. The ER of gasification increases if the air introduced into the gasifier increases. The higher the ER, the lower the LHV of the syn-gas produced. To produce syn-gas with acceptably low tar and high LHV levels and with a high biomass conversion rate, optimization of the operation of a gasifier system is necessary (Devi et al., 2003).

2.6 Biomass Resources for Gasification

There are many sources of biomass for gasification. These resources include dedicated energy crops and trees, agricultural food and feed crops, agricultural crop wastes and residues, wood wastes and residues, aquatic plants, animal wastes, municipal wastes, as well as other waste materials (DOE, 2005). To select a right source for gasification, the primary considerations include the energy content, available quantity, supply cost, and gasification possibility. Generally, biomass that contains more carbon has higher energy content. The heating value of plant biomass usually ranges from 14.2 to 15.5 MJ/kg. Global production of biomass is estimated at 220 billion dry tonnes/year, nearly all in the form of natural growth wood, agricultural, and forest residues. Currently, only 1% of the total energy capacity of global biomass has been used for energy. It has supplied about 14% of the total energy consumption for the modern world (Wang and Ding, 1994; Hislop and Hall, 1996; and Hall et al., 1992)

Compared to fossil fuel resources, biomass is not only renewable, prevalent, and worldwide, but also is low in cost, sulphur content, and other minerals. However, it also has some disadvantageous characteristics such as higher water content, lower unit thermal output, lower density, and more difficulties associated with collection, storage and transportation. As long as local conditions are examined for collection, storage, and transportation, and advanced approaches are used for efficient conversion, then biomass resources can be used efficiently.

Theoretically, biomass resources are potentially the world's largest and most sustainable energy source. Presently, agricultural and forestry residues are the only readily available bio-fuels for gasification. These residues can be divided into three categories:

- Stover – residues left in the field or at the farm after the crop is harvested, such as rice straw, wheat straw, cotton stalks, sorghum stalks, corn stalks, etc.
- Mill residues – produced when the harvested crop is processed at a mill; for example, rice husks, sawdust, wood chips, bagasse, groundnut shells, coconut shells, coffee husks, etc.
- Forestry residues – lopping and topping left after clear felling, thinning, wind blows, and premature clear felling

Energy crops are crops developed and grown specifically for fuel use. These crops are carefully selected to be fast-growing, drought and pest resistant, and readily

harvested. Energy crops include fast-growing trees, shrubs, and grasses such as hybrid poplars, hybrid willows, and switchgrass, etc. These energy plantations may also be available in the future but are not currently.

The actual supply of biomass for gasification is much lower than that of possible utilizable biomass resources due to economic and environmental concerns. For instance, the availability of agricultural residues for gasification is limited by many factors. Straw is highly dispersed, and high transport costs may be involved if it is centralized and supplied for gasification. Furthermore, crop residues often have local uses in non-energy markets, such as for animal fodder, bedding, and also for board manufacture. Also, in-field residues play an important role in maintaining the long term fertility, structure, and stability of agricultural soils, reducing their availability as a bio-fuel. The amount of agricultural residues available for gasification depends on crop species, local climate, location, and recovery and storage technologies. These factors tend to raise the cost of the bio-fuel supply.

There are fewer limitations for mill and forest residues. Mill residues are concentrated in large quantities at a limited number of mills, where the residues may be an environmental problem or fire danger. These residues are often used to provide heat, and sometimes power to the mill, though the efficiencies of these approaches are usually very low. Mill residues are the most immediately available bio-fuels for gasification (Hislop and Hall, 1996).

Mississippi is a state blessed with numerous natural resources and an environment conducive to growing and producing biomass. Because of the extended growing season,

timber and agricultural crops are grown throughout the year, producing tremendous quantities of biomass. For Mississippi, the estimated supplies of urban and mill residues available for energy uses are 785,000 and 6,029,000 dry tons per year, respectively. The estimated supply of forest residues is 1,775,000 dry tons per year. An estimated 38,000 dry tons per year is available from corn stover and wheat straw. The production potential for energy crops is estimated at 9,305,000 dry tons per year. An estimated 26.1 billion kWh of electricity could be generated with these renewable bio-fuels in Mississippi (Walsh et al., 2000). Seeking proper approaches to utilize these resources and to develop this huge potential market is the ultimate goal of this study. Gasification provides an opportunity to reach this goal.

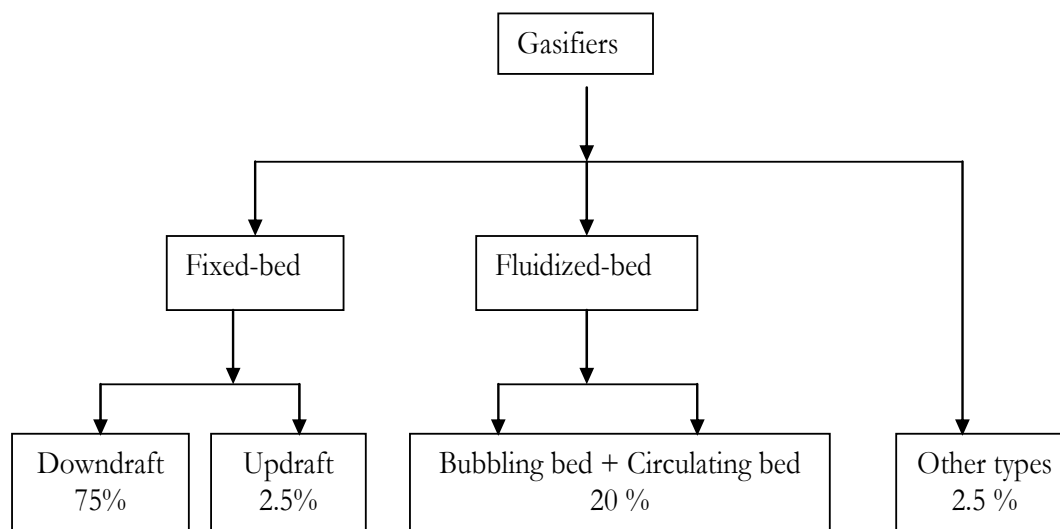

Figure 2-1: Types of Gasifier

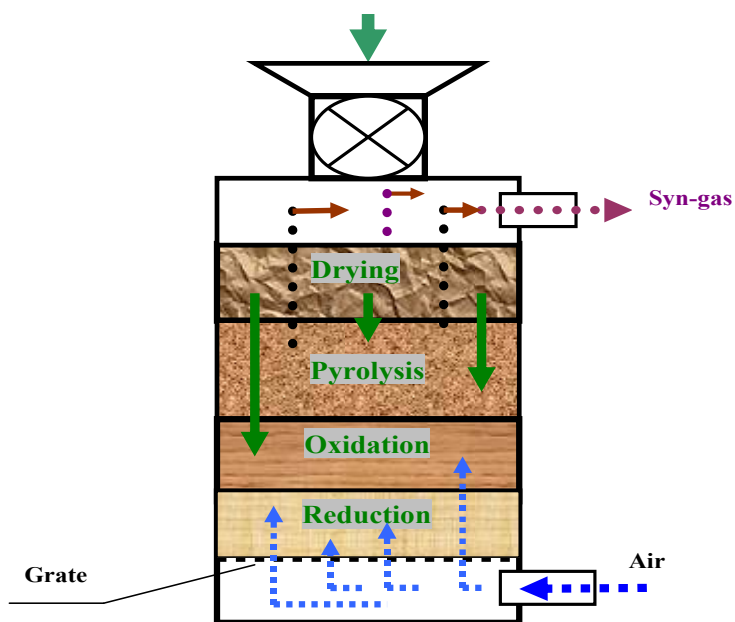

Figure 2-2: Fixed-bed Updraft Gasifier

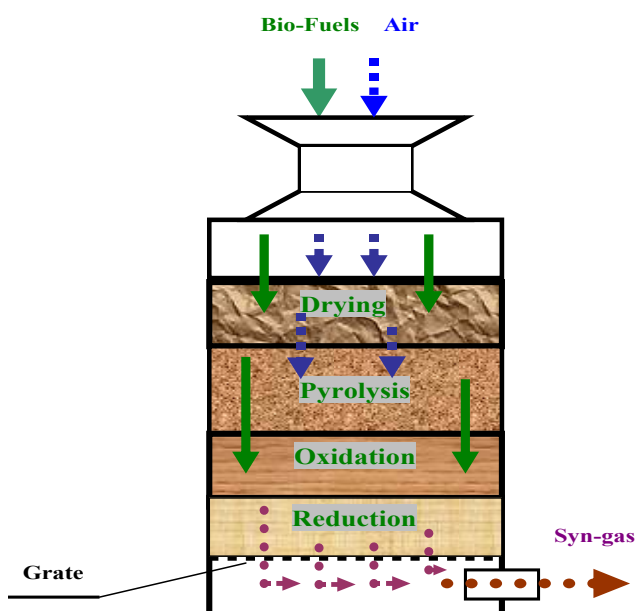

Figure 2-3: Fixed-bed Downdraft Gasifier

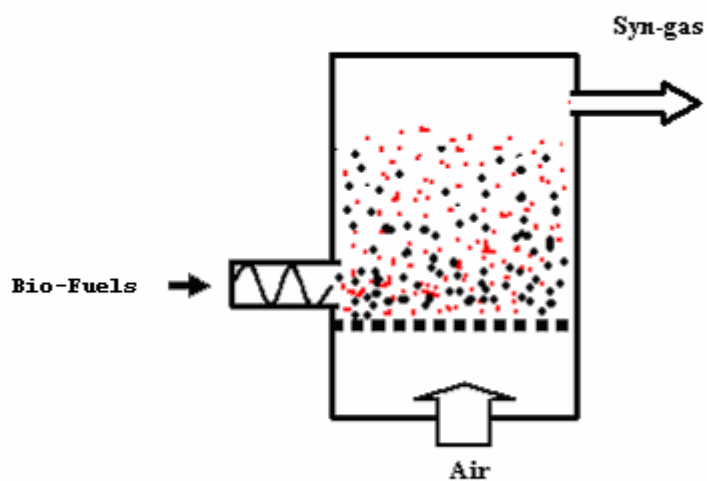

Figure 2-4: Bubbling-Bed Gasifier

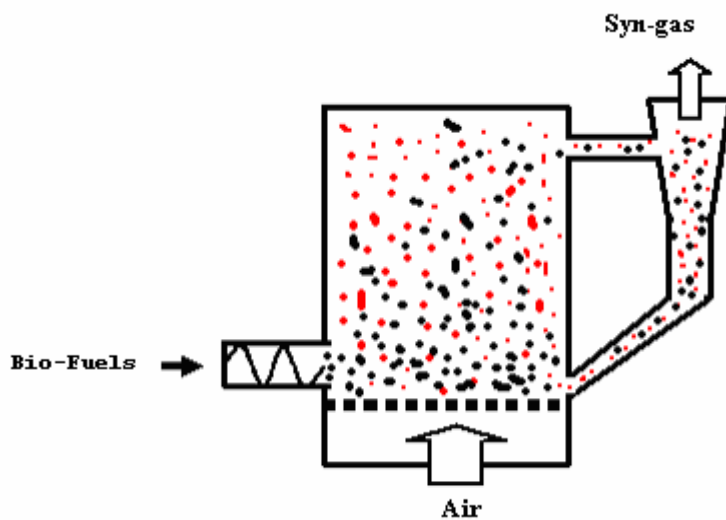

Figure 2-5: Circulating-Bed Gasifier

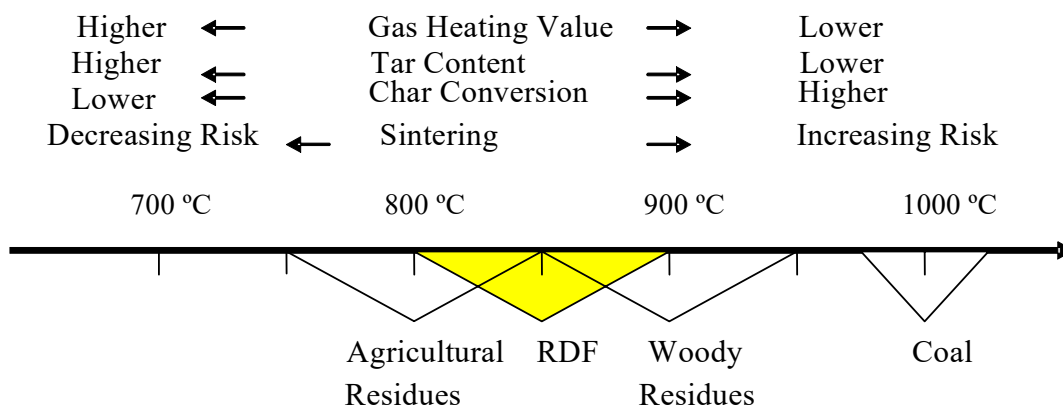

Figure 2-6: Gasification Temperatures for Different Bio-fuels

Note: RDF - Refuse Derived Fuel (Devi et al. 2003)

CHAPTER III

SYN-GAS QUALITY

This section presents important parameters of syn-gas quality, and explains the calculations associated with these parameters. Data concerning acceptable tolerances for fueling ICEs are also presented. These data serve as guidelines in the later suitability evaluations of syn-gas produced with the RFGG.

3.1 Syn-gas Quality

The term, syn-gas quality, is used to indicate the degree to which syn-gas is suitable for end-use equipment. It is represented by several parameters, including tar concentration, particulate concentration, LHV, and chemical composition.

3.1.1 Syn-gas Composition

The syn-gas produced from biomass gasification is a mixture of combustible and noncombustible gases. The major combustible components in the syn-gas include CO, H₂, and CH₄. The major noncombustible components are CO₂, N₂, and H₂O. These components make up about 99% of most syn-gas produced. Due to measurement condition limitations, only CO, CO₂, CH₄, O₂, and H₂ were measured in this study.

Normally, O₂ content of the syn-gas was below 500 ppm, so it was considered negligible. Thus, the discussion of syn-gas composition herein includes only CO, CO₂, CH₄, and H₂.

The LHV of syn-gas is defined as the net energy released during oxidation of a unit of bio-fuel, excluding the energy required for vaporization of the water contained by the bio-fuel and the water produced from combustion of the bio-fuel. Generally, the LHVs of biomass syn-gas vary from 4.5 to 6.0 MJ/m³ depending upon relative proportions of combustible components (Turare, 1997). Since only CO, CO₂, CH₄, and H₂ were considered, the LHV of the syn-gas produced from hardwood chip gasification could be determined by the relative amounts of CO, H₂, and CH₄. The LHV can be estimated with Equation 3-1, in which the combustible components are counted in volume percentages:

$$\text{LHV} = L_{\text{CO}} * P_{\text{CO}} + L_{\text{H}_2} * P_{\text{H}_2} + L_{\text{CH}_4} * P_{\text{CH}_4} \quad (3-1)$$

Where:

L_{CO}	=	the low heating value of CO
P_{CO}	=	the percentage of CO in syn-gas
L_{H_2}	=	the low heating value of H ₂
P_{H_2}	=	the percentage of H ₂ in syn-gas
L_{CH_4}	=	the low heating value of CH ₄
P_{CH_4}	=	the percentage of CH ₄ in syn-gas

According to a report provided by National Renewable Energy Laboratory (NREL) (Waldheim and Nilsson, 2001), $L_{\text{CO}} = 12.622 \text{ MJ/ Nm}^3$, $L_{\text{H}_2} = 10.788 \text{ MJ/ Nm}^3$, and $L_{\text{CH}_4} = 35.814 \text{ MJ/ Nm}^3$. The formula for calculating LHV of syn-gas can thus be represented as

$$\text{LHV} = 12.622 P_{\text{CO}} + 10.788 P_{\text{H}_2} + 35.814 P_{\text{CH}_4} \quad (3-2)$$

For this study, all LHVs of syn-gas are estimated from Equation (3-2).

3.1.2 Impurities in Syn-gas

Undesirable impurities in syn-gas include tar, particulate, sulphur compounds such as hydrogen sulphide (H_2S), and nitrogen (N) compounds (NH_3 , HCN). They and their condensates are corrosive and pollutants in exhaust gases. The generation of H_2S is of little importance in biomass gasification as long as the sulphur content of the bio-fuels does not exceed 0.5%. The amount of NH_3 and HCN produced in the syn-gas depends on the N content of the bio-fuels. Those with nitrogen content less than 2% are safe for gasification (Turare, 1997). The N_2 within air is considered as inert gas and non-reactive with bio-fuel constituents when gasifying pressure and temperature are not extremely high. The N content in the hardwood chips used in this study did not exceed 2%. Based on the relatively high influence of tar and particulate concentrations on the end use of syn-gas, and measurement condition limitations, the only impurities considered in this study were tars and particulates.

In traditional gasification work, the term “Tar” was defined to represent the materials in the product stream that were condensable in the gasifier or in downstream processing steps or conversion devices (Milne et al., 1998). There are different tar definitions and sampling methods in practical use, which cause data from different sources to be difficult to compare. A common definition of tar was presented in an international tar sampling meeting by the Directorate General of the European

Commission (DG XVII) and the U.S. Department of Energy that tars are hydrocarbons with molecular weight higher than benzene (Li, 2002; Maniatis and Beenacker, 2000; and Abatzoglou et al., 2000). There is still no standard method for determining the concentration of tars or particulates in syn-gas, but a provisional version of the tar protocol has been issued (Li, 2002). The measurement value of tars and particulates in syn-gas still depends on the sampling methods and measuring parameters, such as condensation temperature, sampling duration, sampling flow rate, solvent used, etc.

Tar concentration is generally defined as the total weight of tars per unit volume of syn-gas. In this report, the volume of syn-gas is presented as normal volume, Nm³/h, (also known as standard ambient condition volume, in which the gas temperature is 25°C, and pressure is 1.0 ATM).

$$C_t = \frac{W_t}{V_g} \quad (3-3)$$

Where:

- C_t = the concentration of tars in syn-gas
- W_t = the weight of tars in syn-gas
- V_g = the normal volume of syn-gas

Particulate concentration is defined as the total weight of particulates per unit volume of syn-gas.

$$C_p = \frac{W_p}{V_g} \quad (3-4)$$

Where:

C_p = the concentration of particulates in syn-gas
 W_p = the weight of particulates in syn-gas

3.1.3 Biomass Conversion Rate

Biomass conversion rate (CR) is defined as the total volume of syn-gas produced per unit weight of biomass. It relates to the aspects of economics and efficiency in the gasification process.

$$CR = \frac{V_{tg}}{W_f} \quad (3-5)$$

Where:

CR = the conversion rate of biomass gasification
 V_{tg} = the total normal volume of syn-gas produced
 W_f = the weight of of bio-fuel consumed

Biomass conversion is also represented by carbon conversion rate. The carbon conversion rate (CCR) is defined as the ratio of the weight of carbon in the syn-gas to the weight of carbon in the bio-fuel used in gasification. It is estimated with Equation (3-6):

$$CCR = \frac{W_{cs}}{W_{cf}} \times 100 \% \quad (3-6)$$

Where:

CCR = the carbon conversion rate of biomass gasification
 W_{cs} = the weight of carbon in syn-gas
 W_{cf} = the weight of carbon in bio-fuel consumed

3.2 Syn-gas Quality for Internal Combustion Engine Use

The operation of an ICE put high demands on the syn-gas quality. The major properties of concern are heating value, composition, and contamination such as tars and particulates from the syn-gas itself. From the long-term perspective, contamination will be important as it will influence the overall lifetime operation of the ICE. The contaminants may also be harmful to the environment if they are emitted together with exhausted gas (Fredriksson, 1999).

Currently, there are no common standards to evaluate syn-gas quality for ICE use. There are also very few well-defined and long-term data on the tolerances of tar or particulate concentrations for various ICEs (Milne et al., 1998). The tolerable amounts of these substances depend on the type and the arrangement of the ICE. FAO (1986), Tiedema et al. (1983), Stergarsek (2004), and Heesch et al. (1999) suggested some tolerable average amounts for LHV, tars, and particulates for currently available ICEs, which are presented in Table 3-1. These values are used as a guide for evaluating the suitability of syn-gas in this study.

Table 3-1: Acceptable Syn-gas Quality for ICE Operation

Item	Value
LHV	greater than 4.2 MJ/m ³
Particulates	lower than 50 mg/m ³ , preferably lower than 5 mg/m ³
Tars	lower than 50 mg/m ³

CHAPTER IV

MATERIALS AND METHODS

4.1 Overview to Technical Approach

This experimental study was conducted in five phases. Figure 4.1 presents the steps for the project and experimental performance. A description for each phase is presented as below:

Phase I: Material preparation. Hardwood chips were obtained from a local source. Properties of the hardwood chips were determined. These hardwood chips were stored for use throughout this study.

Phase II: Experimental facility preparation. A fixed-bed downdraft gasifier system was purchased and installed, and then some initial tests were conducted, and the system was modified for this study.

Phase III: Experimental design. Based on knowledge gained from the literature and preliminary studies, the independent and dependent variables for this experiment were selected. By using a two-factor, three-level factorial experimental design, the experimental matrix for this study was established.

Phase IV: Data acquisition system design. To collect the required data with high measurement accuracy, four data acquisition systems were utilized. These included an automatic measurement system, a syn-gas composition measurement system, a tar and particulate analysis system, and a near-infrared (NIR) moisture measurement system.

Phase V: Experimental runs and data collection. During this phase of study, a total of 23 runs were conducted. The variables studied and parameters measured are shown in Figure 4-1.

4.2 Material Description and Preparation

As the first stage of the overall biomass gasification project at Mississippi State University, only hardwood chips were used in order to determine the operational behavior and the effects of operating parameters of the RFGG system. More species of bio-fuels are to be considered in later research. The hardwood chips used in this study were obtained from the Weyerhaeuser Company, Columbus, Mississippi, and were transported to the gasification laboratory in the summer of 2004. These chips were of red oak, with length usually less than 75 mm (about 3 in.). A photograph of the hardwood chips is given as Photo 4-1.

The hardwood chips were piled on an outdoor concrete pad adjacent to the gasification laboratory and covered with plastic. They were stored outside for at least three months before experimental use. The original moisture content was around 25%. The chips were generally dried by forced ambient air with fans to approximately 12%

before they were gasified. Some properties of the hardwood chips were determined and are shown in Table 4-1.

Table 4-1: Properties of Hardwood Chips (Dry Matter)

Sample	Carbon Content	Nitrogen Content	Ash Content	Density	Heating Value
Species	% (weight)	% (weight)	% (weight)	g /cm ³	MJ/ kg
Hardwood	50.6	0.3	0.6	0.2	19.59

4.3 Gasifier System Operation

The gasifier system used in this study, the RFGG system, was originally designed by CPC to produce syn-gas at load levels up to 18 KW (electrical equivalent), and gas flow rate outputs ranging from 30 to 60 Nm³/h. The RFGG system consists of a feeder unit, a gasifier unit, a char knock-out pot, a char bin, a heat exchanger, a filter, and a gas flare, as shown in Photo 4-2. A control system (also known as the controller) is included but is not shown in this photo. The gasification flowchart of this system is shown in Figure 4-2. The operation of the RFGG is described in the following section.

4.3.1 Feeder Unit

After the RFGG was received from CPC, initial shakedown tests were conducted. During these runs, it was quickly found that the original screw conveyer of the RFGG (Photo 4-3) was inadequate for the hardwood chips to be used in this study, as it often experienced binding such that it would no longer convey the chips. The feeder unit was

replaced with a new belt conveyer (Photo 4-4). The new feeder unit worked well for feeding hardwood chips in the later runs.

The new feeder unit consists of a bio-fuel level detector, a belt conveyer and a day bin. The capacity of the day bin is approximately 0.5 m³. After the bio-fuel was weighed, it was manually loaded into the day bin, and then automatically delivered into the gasification chamber of the RFGG by the belt conveyer. Bio-fuel feeding was controlled by the RFGG controller based on the level signal from the bio-fuel level detector, which was installed at the top of the gasifier. When the bio-fuel level was lower than an established height, the detector would send a signal to activate the conveyer to feed bio-fuel. When the gasifier was full, the conveyer was turned off based on a “full” signal from the detector.

4.3.2 Gasifier Unit

The RFGG is a fixed-bed downdraft gasifier system with air as the oxidant. Its operating principle and structure are very similar to those indicated earlier in Figure 2-3. The gasification chamber of the RFGG is open to atmospheric conditions. There is not only a primary air supply from the top entrance of the chamber, but also a secondary air supply from the char air blower (Figure 4-3). A blast gate installed at the top entrance will close to isolate the reaction chamber from ambient air when the system is being shut down. A grate at the bottom of the gasification chamber supports the bio-fuel and maintains a stationary reaction bed.

At the beginning of an experiment, the control system of the RFGG was initialized, and the RFGG was started. During start up, the roots blower of the RFGG was first turned on, drawing the primary air from the top entrance into the gasification chamber and throughout the RFGG system. The higher the gas flow rate was set, the more air was drawn into the chamber. The heaters in the chamber were also turned on to warm up the system. Generally, a low gas flow rate was set during start up. The heater took 30 to 40 minutes to warm up the system, depending on ambient temperature and relative humidity. When the temperature of the air flowing into the bag filter reached 50°C, the pre-placed charcoal in the gasification chamber was ignited with an internal electric heating element, and then the charcoal's oxidization caused more heat to be released to increase system temperatures. As the charcoal was combusted, more bio-fuel was fed into the gasifier by the feeder as controlled by the bio-fuel level detector. The bed vibrator of the RFGG cycled on and off at a pre-determined frequency and amplitude to prevent the bio-fuel and char from bridging in the chamber, and to move bio-fuel through the gasifier. After the system warmed up, the heater was turned off automatically, and the gas flow rate was gradually increased to the desired value, and then the system was under fully automated control.

The gasification process in the RFGG followed that described previously for downdraft gasifiers. Normally, bio-fuels undergo four steps during gasification: drying, pyrolysis, oxidation, and reduction. In this study also, the bio-fuels were dried as they were fed into the reactor, and then were pyrolyzed as they progressed through the gasification chamber. As mentioned previously, secondary air was introduced with the

char air blower and adjusted automatically by the controller, while the primary air supply from the top of the chamber was constant at a certain gas flow rate. This method of operation improves the oxidation reactions of bio-fuels and the products of bio-fuel pyrolysis in the gasifier. The oxidation zone temperature was typically raised to around 1000°C. Since the amount of air introduced into the gasifier was insufficient to oxidize all the bio-fuel in the gasifier, some carbon remained as char residue. The char residue (about 5 to 15% of original bio-fuel mass) then reductively reacted with the combustible gases, CO₂, and H₂O vapor, to produce more CH₄, CO, and H₂ in the reduction zone. When the tars contained in the mixture went through the high temperature zone near the grate at the bottom of the reaction chamber, they also were reduced to CH₄, CO, and H₂. These gases together form the combustible portion of the syn-gas. The syn-gas, including some non-oxidized char and ash particles, flowed downward and exited the chamber below through the grate. The temperature of the syn-gas was reduced somewhat due to the endothermic reduction reactions taking place. However, the syn-gas leaving the gasifier was still at a high temperature around 700°C (CPC, 2003).

4.3.3 Separating and Cooling Unit

The separating and cooling unit of the RFGG included a char knock-out pot, a char bin, and a heat exchanger. The exiting mixture of char, ash and syn-gas from the gasifier unit entered the char knock-out pot with a relatively high velocity. Then the large char particles dropped out of the flowing gases into the char bin due to a reduction in velocity, while the syn-gas and entrained smaller particles continued downstream to the heat exchanger. As much as 70% (by weight) of the entrained char was removed from the

gas stream in the char bin. Syn-gas left the char knock-out pot at a temperature ranging from 600 to 700°C, and then this hot gas stream entered the forced-air heat exchanger, where it was cooled down to approximately 100°C (CPC, 2003).

4.3.4 Filter Cleaning Unit

The cleaning unit of the RFGG included a bag filter, a drum, and an agitator (Photo 4-5). After leaving the heat exchanger, the syn-gas was filtered to remove any extra-fine particulate matter and some tars. Normally, the agitator mechanism installed in the filter drum was automatically activated by the controller when a certain pressure drop across the filter drum was reached. This agitator mechanism shook the bag to remove built-up char cake, thus allowing the system to continue to operate (CPC, 2003). After filtration, syn-gas was drawn by the roots blower and delivered to the gas flare of the RFGG for combustion in this study.

4.3.5 Gas Flare

After syn-gas cleaning, the syn-gas can be delivered to storage, refining for end-use, or is simply flared. As mentioned, the syn-gas in this study was delivered to a gas flare for combustion. Generally, the gas flare worked well, but since the flare was placed outside during operation, it was subjected to the elements, which during a rain event could possibly lead to system shutdown.

4.3.6 Control System

The control system of the RFGG consists of a series of sensors, such as thermocouples, pressure sensors, flow meters, etc., a control box including circuit boards,

and an associated computer with control program software, all purchased from CPC as part of the RFGG system. The RFGG is capable of fully automated start-up, operation, and shut-down. To initiate the system, one only needs to manually set the grate temperature and gas flow rate in the control software. When the RFGG was ready to run, the power was turned on. The computer then proceeded through system initializing self-tests. These tests verify all temperatures and pressures of the system, and so all sensors were automatically checked for reasonable temperatures, pressures, etc. The gasifier would not operate if there were any indicated failure. After passing the system self-test, the operator started automatic operation. The controller went through control Modes 0 through 6 during each test run as detailed below.

Mode 0: The controller initializes the system prior to starting. The gasifier blast gate opens. The program then automatically advances to Mode 1.

Mode 1: The controller verifies that settings for the gasifier, relative to default values, are correct. The default values can be modified manually in text windows on the Run screen, but updated settings are not saved from previous runs. After the Roots blower flow rate reaches $30 \text{ Nm}^3/\text{h}$, the program automatically advances to Mode 2.

Mode 2: The roots blower draws primary air for combustion through the gasifier. Electrical heaters in the gasification chamber are energized to raise the system temperature, and to light the charcoal pre-positioned in the chamber. After the system warms up and ignition occurs, the heaters are automatically turned off. The controller advances to Mode 3 when temperatures at the top of the gasification chamber exceed 100°C , indicating full ignition of the char bed in the chamber.

Mode 3: The feeder will automatically turn on or off in response to the detector signals regarding bio-fuel level in the gasifier chamber. (A dirty site window on the bio-fuel level detector makes the controller act as if the gasifier is full, so the window should be maintained so as to be clean and clear while the system is running). Following three minutes of feeding in Mode 3, the program automatically advances to Mode 4.

Mode 4: In Mode 4, the RFGG system is in fully automatic control. If the system is operating properly, the operator is required only to keep feeding bio-fuel to the gasifier's day bin. However, during the experiments, the operators typically recorded sensor readings at regular intervals and observed system operation to ensure safety.

Mode 5: There are two modes for shutdown of the RFGG system. One is controlled shutdown mode, Mode 5. The other is emergency shutdown mode, Mode 6, which is also used after Mode 5 to complete controlled shutdown. To shut down the system in controlled shutdown mode, such as at the end of an experimental run, the operator selects the controlled shutdown button by clicking it on the control screen. The program then advances to Mode 5. The system shuts down safely with minimum smoking and enough charcoal is left in the chamber to initiate the next run. At the end of Mode 5 procedures, the system automatically advances to Mode 6.

Mode 6: In Mode 6, the controller closes the blast gate and all valves, and stops all blowers and mechanisms. All of the gasifier temperatures should show a rapid decrease after Mode 6 is activated. (If the gasifier temperatures remain constant or increase, the gasifier blast gate should be checked to be certain that it closed, that the char blower is

off, and that all manual valves that could allow air into the system are closed.) If Mode 6 is activated directly by the operator without going through Mode 5, such as if the operator detects an unsafe condition, the fresh bio-fuel already in the gasifier will pyrolyze and create significant quantities of smoke. (The smoke should not be inhaled, as it will contain poisonous carbon monoxide and noxious, irritating fumes). Prior to next run, the running data should be collected and backed-up.

4.4 Experimental Design

The factorial experiment is a common method used to explore the relationships among and the interactions between independent and dependent variables. This section of the report attempts not to describe the theoretical and fundamental aspects of factorial experimental designs, but to outline the methodology used for this data analysis.

To investigate the operation of the RFGG and the effects of operating parameters, the system had to be tested under different operating conditions. Thus, syn-gas quality and operational parameters were measured during a series of experiments incorporating different conditions, and then the effects of variation in the parameters on syn-gas quality were examined. The series of test runs was based on a factorial experimental design, which, when properly conceived, can lower experimental cost and duration. A two-factor, three-level, factorial experimental design (L_3^2 experiment) was employed (Petersen, 1985). The number of experimental treatments was nine ($3^2 = 9$), so the study required nine runs for a single test replication.

The selection of experimental factors and the levels of those factors are critical for factorial experiments. Previous research has indicated that reactor temperatures and oxidation agents can significantly affect syn-gas quality. Since the gasification chamber of the RFGG was open to ambient conditions while running, directly determining the amount of air (oxidation agent) introduced into the chamber, which is automatically adjusted by the controller of the RFGG, was difficult, and thus the air ratio was not considered as an experimental factor in this study. Instead of air ratio, the gas flow rate of the RFGG was selected as an experimental factor. The reason for this selection is that the amount of air introduced into the gasifier included only two parts, primary air and secondary air. The primary air (also primary oxidation agent) depends on the gas flow rate, and the secondary air was automatically controlled by the controller of the RFGG with a char air blower. The gas flow rate indicated the air involved in gasification and was easily determined by the controller. The grate temperature of the RFGG was selected as another experimental factor, because it was directly determined at the reaction zone and was an indicator of reactor temperature. Based on grate temperature, the controller automatically controls bio-fuel gasification in the RFGG system at a relatively stable state. These two independent variables (also known as factors or inputs) are the only operating parameters of the RFGG controlled by the operator, and they are expected to have significant effects on the syn-gas quality and bio-fuel conversion rate during the gasification process.

The bio-fuel gasification process in the gasifier was assumed to be that of a system affected by these two independent variables, ξ_p . Several responses of the produced

syn-gas to these independent variables (ξ_p), such as bio-fuel CR, syn-gas yield and composition, LHV, and tar and particulate content, were selected as dependent variables, y_h . The relationships between these independent variables (ξ_p) and dependent variables (y_h) is presented simply in Figure 4-4.

A set of mathematical functions (f_h) describes the relationships between the dependent variables (y_h) and the independent variables (ξ_p) for these two-factor three-level experiments. The relationships can be presented as follows:

$$y_h = f_h(\xi_p) \quad (4-1)$$

In this study, $h = 1, 2, 3, \text{ or } 4$, and $p = 1 \text{ or } 2$.

For each dependent variable (y_h) per test run, the yield response can be described by Equation 4-2 (Petersen 1985):

$$y_{ijk} = \mu + \rho_i + \alpha_j + \beta_k + (\alpha\beta)_{jk} + \varepsilon_{ijk} \quad (4-2)$$

Where

y_{ijk} = the yield of a dependent variable at the j_{th} level of grate temperature and k_{th} level of gas flow rate in the i_{th} replication.

μ = overall mean yield.

ρ_i = the effect of the i_{th} replication measured as a deviation from μ .

α_j = the effect of the j_{th} level of grate temperature measured as a deviation from μ .

β_k = the effect the k_{th} level of gas flow rate measured as a deviation from μ .

$(\alpha\beta)_{jk}$ = the effect of the combination of the j_{th} level of grate temperature with the k_{th} level of gas flow rate, also known as the interaction effect of grate temperature and gas flow rate.

ε_{ijk} = the random error during the experiment

Both the independent and dependent variables were measured as accurately as possible for each run. The relationship between and the effects of grate temperature and gas flow rate in the gasification process can be determined from the model described above. Based on the results of several initial tests, and considering low, medium, and high capacities of the RFGG system, three levels of both independent variables were selected (Table 4-2). Full factorial combinations of the independent variables are shown in Table 4-3. This experimental matrix was performed in duplicate for purposes of replication, so a total of 18 runs were conducted as part of this study. A final experimental matrix was generated by randomizing the running sequences (Table 4-4).

Table 4-2: Independent Variable Levels

Variable	Unit	Low	Medium	High
Grate temperature	°C	750	850	950
Gas flow rate	Nm ³ /h	35	45	55

Table 4-3: Experimental Treatment Combinations

Run #	Temp °C	Flow rate Nm ³ /h
1	750	35
2	750	45
3	750	55
4	850	35
5	850	45
6	850	55
7	950	35
8	950	45
9	950	55

Table 4-4: Randomized Experimental Running Order

Run No.	Gas flow rate (Nm ³ /h)	Grate temperature (°C)
1	55	850
2	35	850
3	35	750
4	55	850
5	45	950
6	55	950
7	45	750
8	35	850
9	35	750
10	55	750
11	35	950
12	45	850
13	45	750
14	45	850
15	35	950

Table 4-4 (Continued)

16	55	950
17	55	750
18	45	950

4.5 Data Acquisition Systems

As part of this study, a number of values of dependent and independent variables were measured. The data acquisition systems used for measuring these variables are described below.

4.5.1 Automatic Data Acquisition System

During each test run, measurements from selected sensors for variables, such as gas flow rate, pressure variations, and temperatures, were recorded every 9 seconds by the automated controller of the RFGG. Data were stored and transferred to an Excel spreadsheet (Microsoft software, Version 2000) for analysis. Example graphs of the automatically collected data files are provided in Appendix B. The locations of the flow meter, gas sampling outlets, thermocouples, and pressure transducers for measuring the variables are shown in Figure 4-5. Details of thermocouple locations in the gasifier chamber are presented in Figure 4-6. The variables measured by sensors or meters are listed in Table 4-5. A typical reactor temperature profile during gasification is presented in Figure 4-7, with the temperature increasing as depth in the gasifier chamber increases. The temperature profile is helpful in analyzing the effects of operational parameters on the produced syn-gas quality.

Table 4-5: List of Automatically Measuring Variables in the Gasifier System

Code	Variable	Code	Variable	Code	Variable
T1	Gasifier Temp. 1	T6	Gasifier out	P1	Gasifier DP
T2	Gasifier Temp. 2	T7	Tar reform	P2	Filter DP
T3	Gasifier Temp. 3	T8	Filter in	F	Gas flow rate
T4	Gasifier Temp. 4	T9	Filter out		
T5	Grate Temp				

4.5.2 Syn-gas Composition Measurement System

The syn-gas produced from hardwood chip gasification contains many components, but only CO, CO₂, H₂, O₂, and CH₄ were considered in this study. As mentioned previously, since O₂ content of the syn-gas was below 1000 ppm, it was ignored. The remaining measured components of syn-gas were measured continuously with a gas analyzer (Model: NOVA 7900P5) at a resolution of $\pm 0.1\%$. The post-filter syn-gas sampling positions are located at the final syn-gas exhaust outlet (Figure 4-5). The gas analyzer was attached to the post-filter gas sampling port, and so the syn-gas was cleaned prior to passing into the gas analyzer. The syn-gas cleaning unit consists of a gas valve, a water trap, a dryer, and a small filter. At the beginning of the measurement, the gas analyzer was turned on, and then the valves were opened, allowing a slip stream of syn-gas to pass into the gas analyzer through the cleaning unit. The composition of syn-gas was thus continuously measured. The measurement flowchart is shown in Figure 4-8. Because the output from the gas analyzer was not integrated with the gasifier system,

the data readings were recorded manually every 5 minutes during each run. These data were averaged and were considered as the average syn-gas composition for each run.

4.5.3 Tar and Particulate Analysis

In addition to syn-gas composition analysis, syn-gas was also sampled for tar and particulate analysis. Samples were collected at both pre- and post-filter collection points, shown in Figure 4-5. All sample collection was conducted in triplicate. A total of six samples were taken for each run. These samples were further sampled and analyzed for tars and particulates as described below.

4.5.3.1 *Syn-gas sampling for tar and particulate analysis*

Syn-gas sampling for tar and particulate analysis consisted of placing pre-weighed filter papers (glass fiber filter paper No. 151, 0.7 μm) into filter holders. The filter holder assembly is shown as Photo 4-6. When the filter assemblies were assembled, they were installed to the gasifier system. One sampling assembly was installed at the pre-filter syn-gas sampling point, and one at the post-filter syn-gas sampling point, shown in Figures 4 and 5. The pre-filter assembly employed a cooling coil with an ice bath ahead of it to cool the syn-gas. This cooled the syn-gas to around ambient temperature (20 to 25°C). Details of this sampling process are shown in Figure 4-9. Only the hot (pre-filter) sample was cooled, and the post-filter syn-gas sample did not pass through the cooling coil as shown in Figure 4-9, because it was already cool.

When the gasifier system reached steady state, syn-gas sampling was started. This consisted of turning on both pre-filter and post-filter sampling assemblies at the same

time. The sampling pumps were allowed to collect at least 70 liters of syn-gas through each sampling system prior to shutting off the systems. Two Dwyer flow meters (Model: GFM-110, 40 liter/min $\pm 1.5\%$) were used for determining the volumes of syn-gas passing through the sampling filter papers in the assemblies. During sampling, the volumes of syn-gas sampled as well as the ambient temperature, pressure, and relative humidity were recorded. As stated previously, this sampling was repeated two additional times during a single run. Once the samples were collected, they were taken to an analytical laboratory for tar and particulate analysis.

4.5.3.2 *Particulate analysis*

Once the tars and particulates were collected in the tar and particulate sampling devices, condensed tars and particulates were collected by separating the particulates from the tars. The first step in particulate analysis was to wash the cooling coil and filtering apparatus with high-purity acetone. This was done by passing the high-purity acetone through the filter paper in the direction of syn-gas flow. Relatively large particulates ($> 0.7 \mu\text{m}$) were left on the filter paper. The smaller particulates ($< 0.7 \mu\text{m}$, ultra-fine) and tars were washed into a pre-weighed bottle along with the acetone. The weight of large particulates was determined by disassembling the filter holder to remove the filter paper containing the large particulates. The pre-weighed filter paper was dried at 68°C until it reached a constant weight. After drying and cooling, the filter paper was weighed at a resolution $\pm 0.00001\text{g}$ with an Ohaus analytical balance (Model AP 250D, 0 - 52 $\pm 0.00001\text{g}$, 52 - 210 $\pm 0.0001\text{g}$), and then the weight of large particulates in the

sampled syn-gas was determined. A detailed description of this procedure is provided in Appendix A.

4.5.3.3 *Tar analysis*

The mass of tars contained in the sampled syn-gas was determined by analyzing the solution of acetone and tar and ultra-fine-particulates, which was produced by washing the filter holder and the cooling coil into a pre-weighed bottle. First the acetone was evaporated from the bottle at 100°C in a water bath. The ultra-fine particulates and tars remained as the residue left in the bottle. The bottle was then dried at 68°C until it reached constant weight. After drying the bottle was cooled down and then weighed at a resolution of 0.00001g with the Ohaus balance. The weight of tars and ultra-fine particulates was determined by the difference between the empty bottle and the bottle containing tars and ultra-fine particulates. After that, fresh acetone was added back to the bottle containing, and then the tars were re-dissolved and decanted. The ultra-fine particulates remained as residues on the wall of the bottle. The bottle was then dried and cooled again, and then reweighed. The difference between the weight of the empty bottle and the bottle containing the ultra-fine particulates was considered to be the weight of ultra-fines particulates. The mass of tars was calculated as the difference between the total weight of ultra-fine particulates and tars and the weight of ultra-fine particulates. The total weight of particulates in the sampled syn-gas was calculated as the sum of the weight of large particulates and the weight of ultra-fine particulates. This procedure is also detailed in Appendix A.

Based on the weights of tars and particulates and the volumes of the syn-gas samples, the tar and particulate contents of the syn-gas were calculated with Equations 3-3 and 3-4, described in section 3.1.2.

4.5.4 Bio-fuel Moisture Content Measurement System

The MC of hardwood chips is an important parameter for gasification. Generally, three samples of the hardwood chips around 500 g each were randomly taken from the day bin of the RFGG for each run. These samples were separately put in plastic bags, and were then taken to an analytical laboratory to determine MC with an Ohaus moisture determination balance (Model: MB 200, 200 ± 0.007 g). Before measuring, the sample was homogenized, and then a roughly 50-g sub-sample was weighed. This sub-sample was dried in the balance at 160°C until the weight of sample was constant. The reduction in weight during drying was considered to be the weight of water contained in the sub-sample. This procedure was repeated three times. The MC of the hardwood chips was calculated with Equation 4-3 (below). Finally, the average of the three MC measurements was considered to be the MC of the hardwood chips for each run.

$$MC = \frac{W_1 - W_2}{W_1} \quad (4-3)$$

Where: MC = the moisture content of hardwood chips
 W_1 = the weight of hardwood chips before drying
 W_2 = the weight of hardwood chips after drying

To examine the distribution of MC in the hardwood chips, an NIR moisture meter (Model: Kette, MM300, $\pm 2\%$) was employed to monitor the moisture content of the hardwood chips online. This NIR MC measurement system consists of an NIR detector and an associated computer with measurement software, purchased as a unit from Kette Company, California. The operating procedure of this system is shown in Figure 4-11, and the NIR detector is shown as Photo 4-7.

The detector was installed above the belt conveyer of the RFGG. As hardwood chips were delivered to the gasifier of the RFGG, the detector emitted a beam of NIR energy focused on the hardwood chips, and the system measured the MC as related to reflected NIR energy, and then recorded it. The MCs were also shown on the screens of the detector and the associated computer in real time.

4.5.5 Conversion Rate Measurement

To explore the bio-fuel conversion rate (CR) and the carbon conversion rate (CCR) of the gasification process, other parameters, such as bio-fuel consumption, the weight of carbon input, the syn-gas yield, the weight of carbon output in the syn-gas, and the weight of ash and char residues, were also measured as part of this study. The measurement of these variables was relatively simple, and the procedure is given briefly below.

The total weight of bio-fuel consumed (W_{tf}) was determined by the amount of all hardwood chips fed into the gasifier for each run (Equation 4-4). The hardwood chips were weighed manually with a scale (Model Arlyn 22 $\pm 0.005\text{kg}$) before they were fed

into the gasifier of the RFGG. The total volume of syn-gas yield (V_{tg}) was calculated with Equation 4-5. For a given experimental run, the measured data and running time were recorded only from the point when the gasifier reached steady state to the point when shutdown was initiated. The feeding rate (FR) for each run was estimated with Equation 4-6.

Ignoring the small carbonic compounds in the syn-gas, the carbon content (C_{cs}) in the syn-gas was calculated by summing the carbon contained in the carbonic compounds (CO , CO_2 , and CH_4) considered in this report. The weight of carbon in these compounds was estimated with Equation 4-7, following the ideal gas law. The syn-gas was treated as an ideal gas due to operating with ambient pressure. The total weight of carbon (W_{cs}) in the syn-gas was determined with Equation 4-8. The carbon content ($C_{cf}=50.6\%$) in the hardwood chips used in this study was determined by the Chemistry Laboratory at the Department of Chemistry, Mississippi State University (Table 4-1). The weight of carbon input to the gasifier was determined with Equation 4-9, and then the CCR was estimated with the Equation 3-6.

The masses of the char and ash residues were determined by collecting all char left in the char bin and all ash left in the filter drum after the RFGG system shutdown. After the RFGG system cooled down, the char bin was opened, and all char residues in the char bin were collected with a vacuum. The filter drum was also opened, and all ash residues in the filter drum were collected with the vacuum, and then the char and ash residues were weighed with the Arlyn scale.

In this study, the weight of carbon in sys-gas is also estimated by the difference between the weight of carbon input to the gasifier and the weight of carbon left as char-ash residue in the gasifier after gasification. The char residue of wood chips is considered as 100% of carbon. The ash residue of wood gasification in downdraft gasifier typically contains 33% ash (mineral), 66% carbon (Reed, 1996). Based on this estimation, the CCR is also estimated by equation 4-10 for comparison. The CR of hardwood chips was also revealed by the gasification residue ratio. The residue ratio (RR) is defined as the ratio of the total weight of char-ash residues to the total weight of bio-fuel's consumption during gasification. It was estimated with the Equation 4-11.

$$W_{tf} = \sum W_{fi} \quad (4-4)$$

$$V_{tg} = \sum G_{fi} * t_i \quad (4-5)$$

$$FR = \frac{W_{tf}}{t} \quad (4-6)$$

$$W_{ci} = \frac{C_{ci} M_i P_i V_{tg}}{RT} \quad (4-7)$$

$$W_{cs} = W_{c1} + W_{c2} + W_{c3} \quad (4-8)$$

$$W_{cf} = (1 - M_{cf}) W_f C_{cf} \quad (4-9)$$

$$CCR = \frac{W_{cf} - W_{cr}}{W_{cf}} \times 100 \% \quad (4-10)$$

$$RR = \frac{W_c + W_a}{W_f} \times 100 \% \quad (4-11)$$

Where:

- i = 1, 2, ...n
- C_{cs} = the carbon content in syn-gas
- C_{cf} = the carbon content in bio-fuel
- G_{fi} = the gas flow rate during running period
- M_i = molar mass of carbonaceous gas (CO, CO₂, or CH₄)
- M_{cf} = moisture content of bio-fuel (hardwood chips)
- P_i = output pressure of carbonaceous gas (CO, CO₂, or CH₄)
- R = gas constant
- T = output temperature of syn-gas
- t_i = the running time at the desired gas flow rate
- t = the running time at the desired conditions
- V_{tg} = the total volume of produced syn-gas at the desired conditions
- W_a = the weight of ash in the filter drum at the end of each run
- W_c = the weight of char in the collection vessel at the end of each run
- W_{ci} = the weight of carbon in carbonaceous gas (W_{c1} in CO, W_{c2} in CO₂, or W_{c3} in CH₄)
- W_{cf} = the weight of carbon in bio-fuels consumed
- W_{cr} = the total weight of carbon residues left in the gasifier
- W_{cs} = the total weight of carbon in syn-gas
- W_f = the total weight of bio-fuels consumed during gasification
- W_{tf} = the total weight of consumed bio-fuels for each run
- W_{fi} = the weight of bio-fuels fed to gasifier during the desired time period

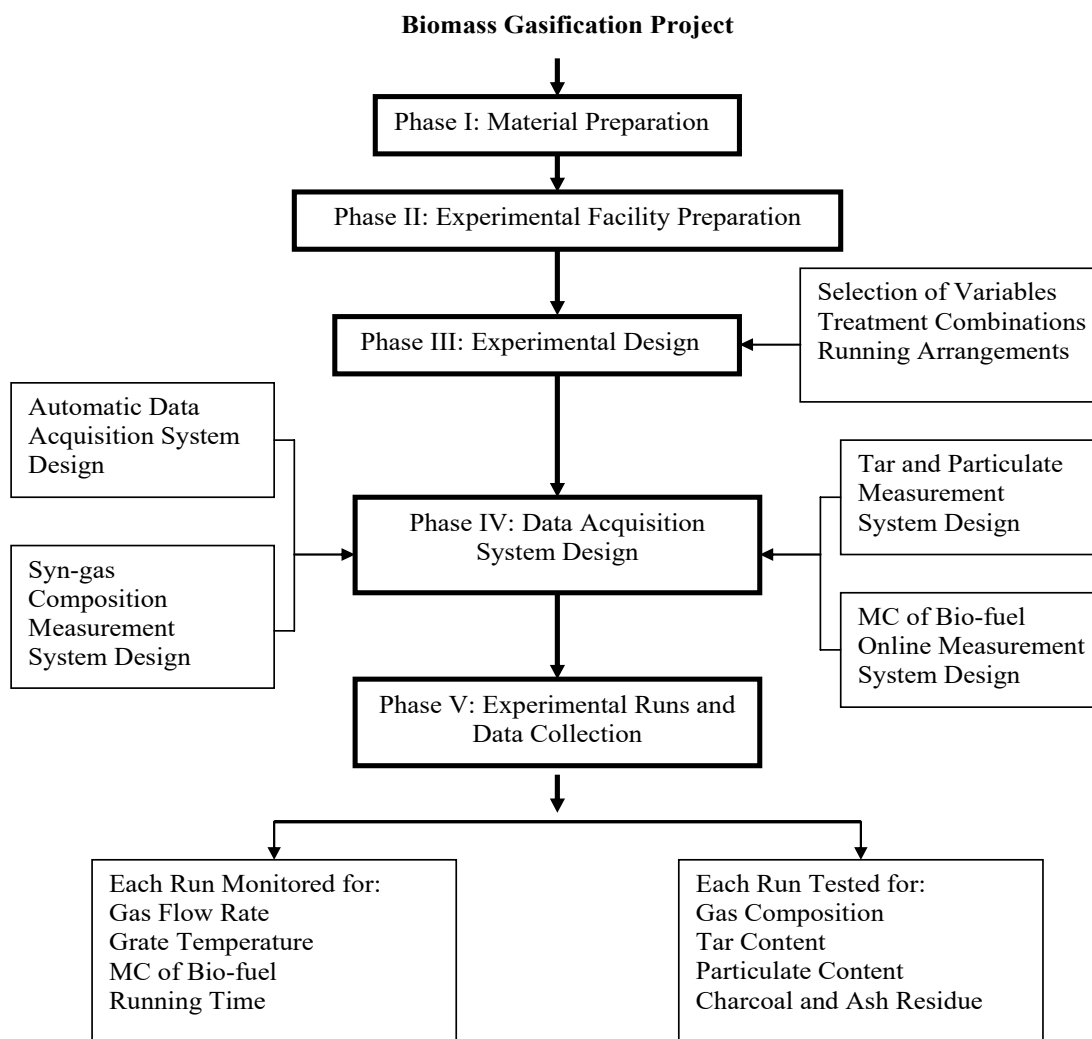

Figure 4-1: Flowchart of Hardwood Chip Gasification Study

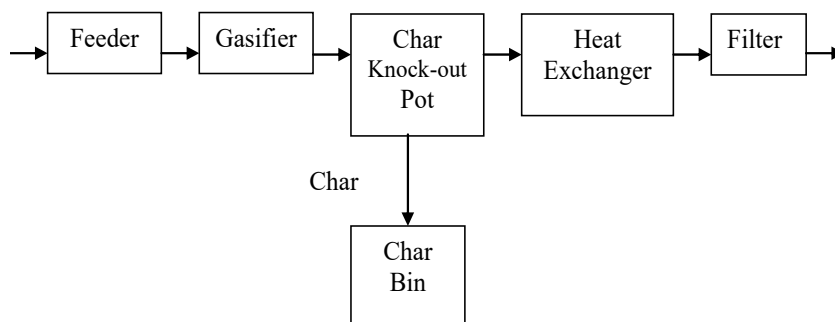

Figure 4-2: Flowchart of Gasification Process in the Gasifier System

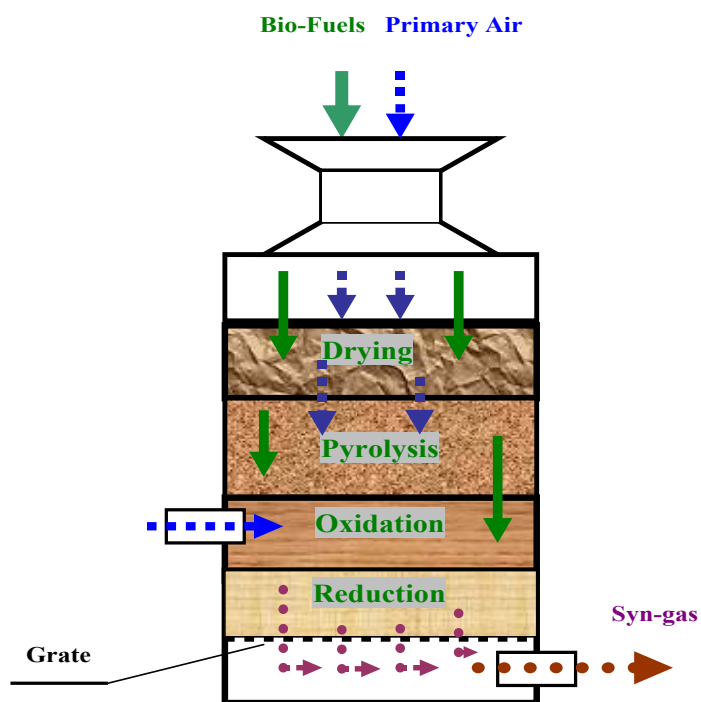

Figure 4-3: Structure and Principle of Gasifier Unit

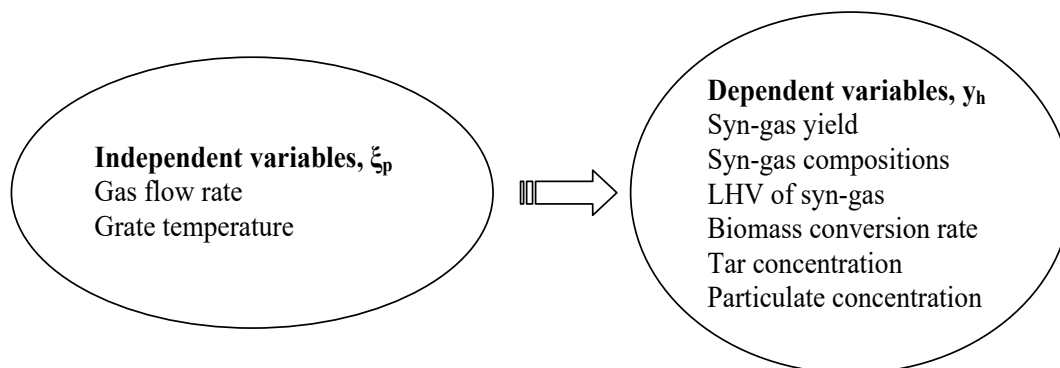

Figure 4-4: Relationships between Independent and Dependent Variables

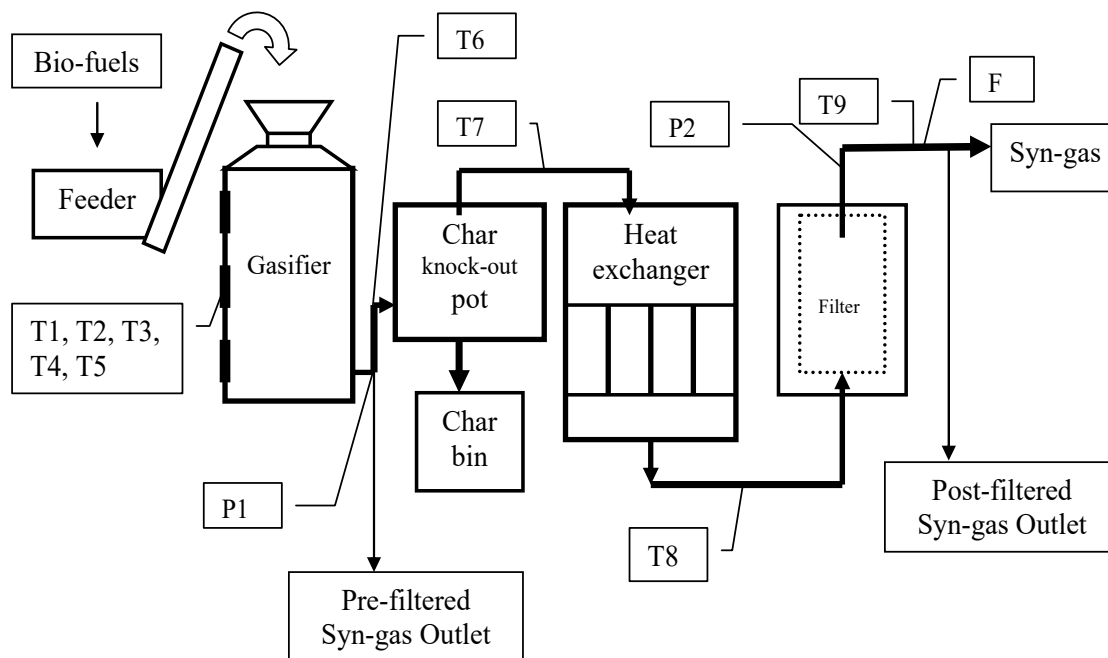

Figure 4-5: Locations of Measuring Sensors in the Gasifier System

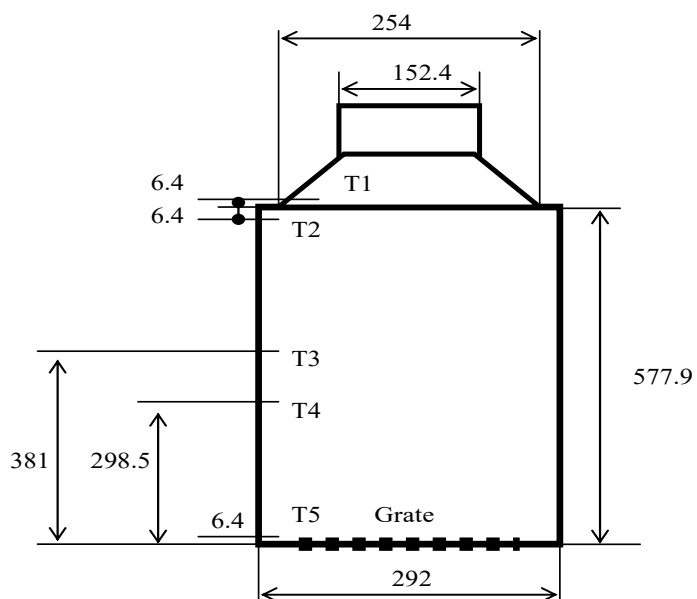

Figure 4-6: Positions of Thermocouples in Gasification Chamber of the Gasifier
 Note: Dimension Units Are in Millimeter (mm)

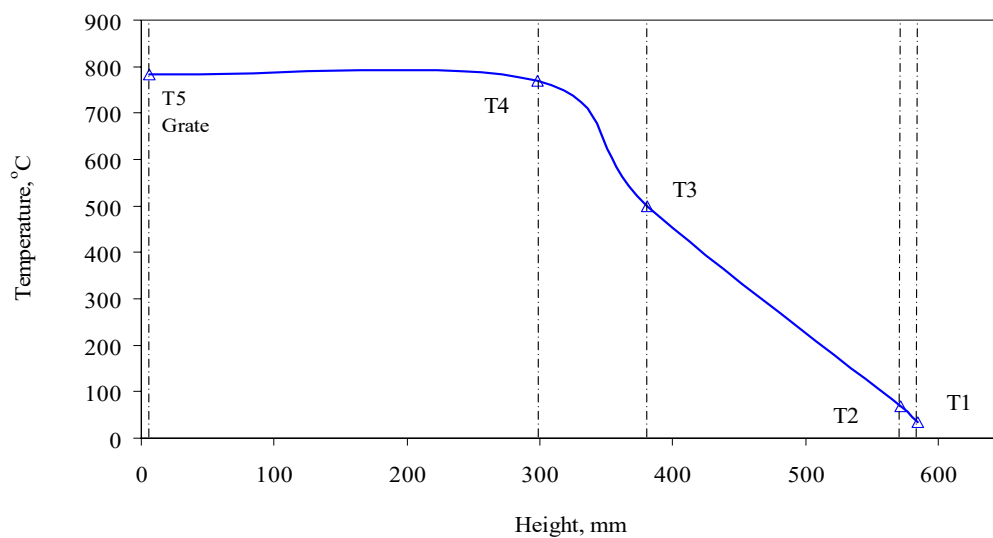

Figure 4-7: Reactor Temperature Profile of the Gasifier System

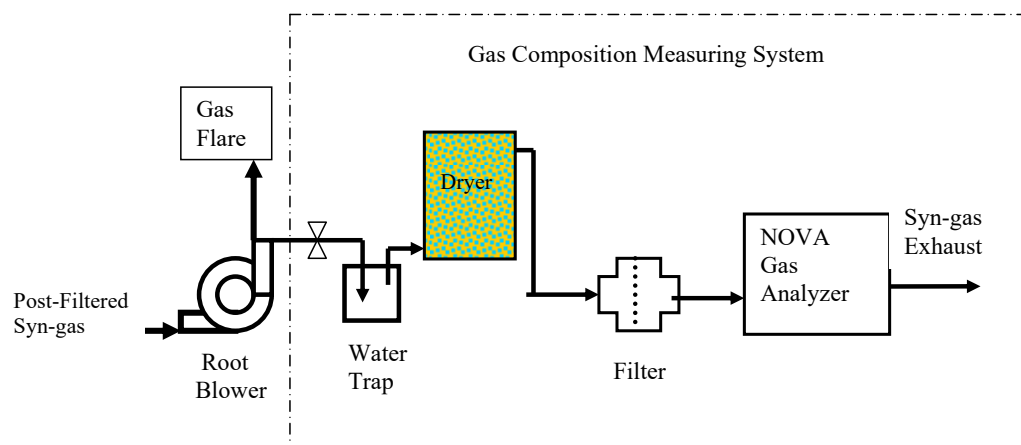

Figure 4-8: Flowchart of Syn-gas Composition Measurement System

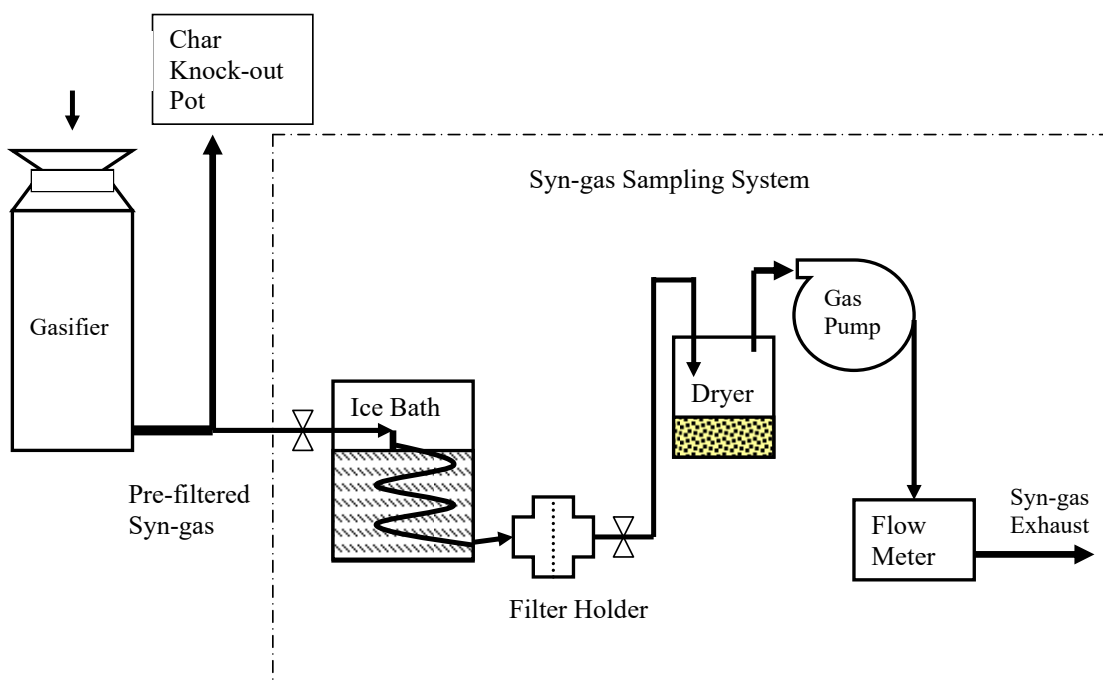

Figure 4-9: Flowchart of Syn-gas Sampling

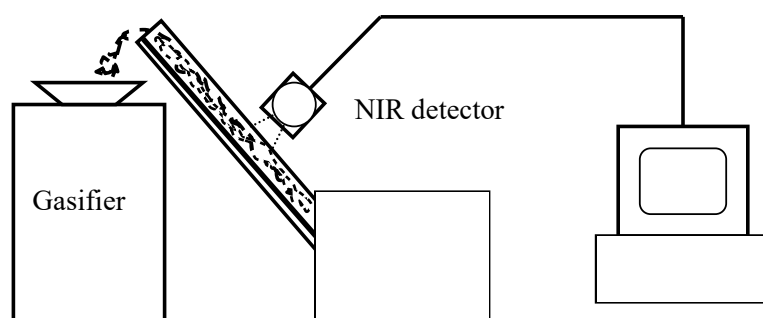

Figure 4-10: Flowchart of Near Inferred Moisture Content Measurement System



Photo 4-1: Hardwood Chips for Gasification

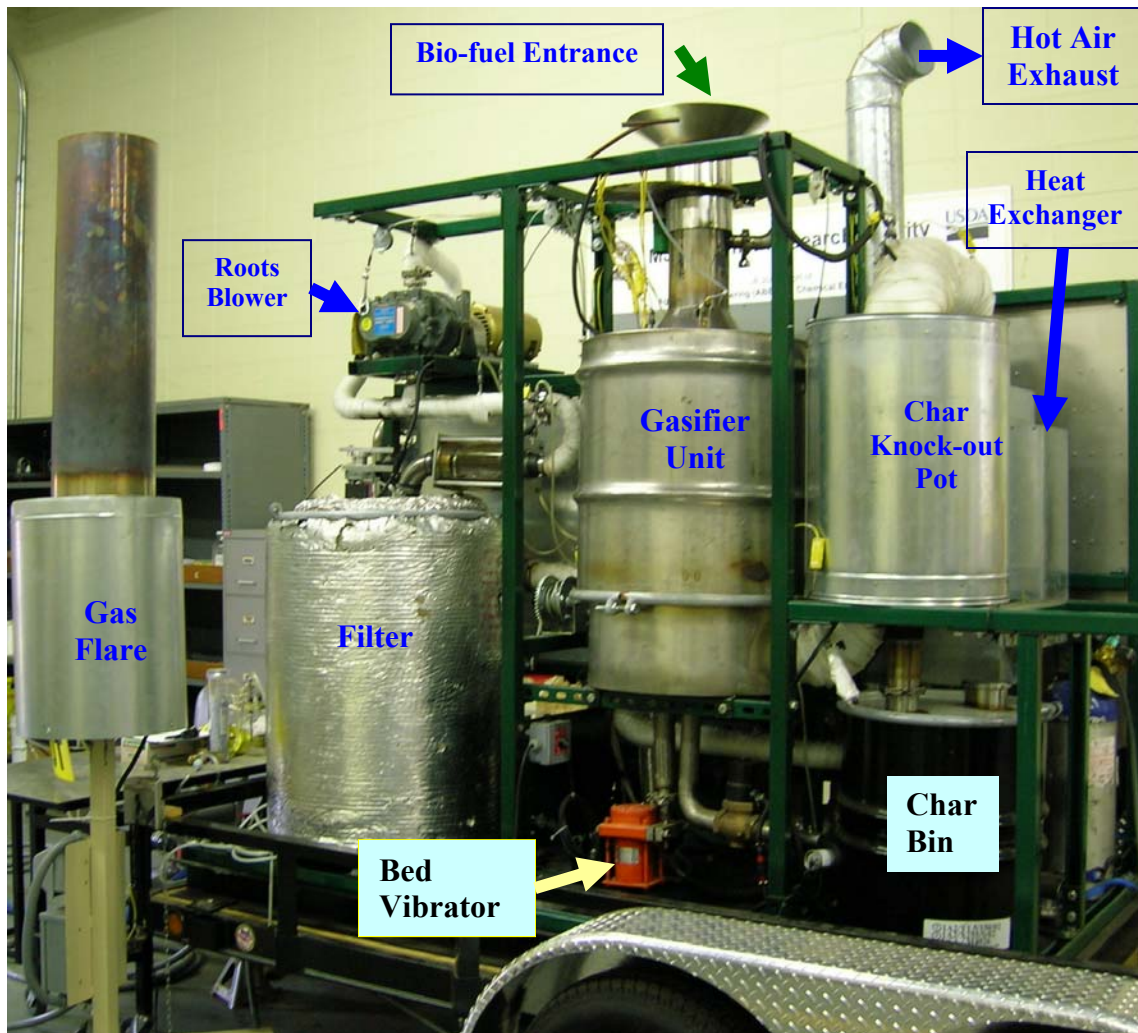

Photo 4-2: Overview of the Gasifier System

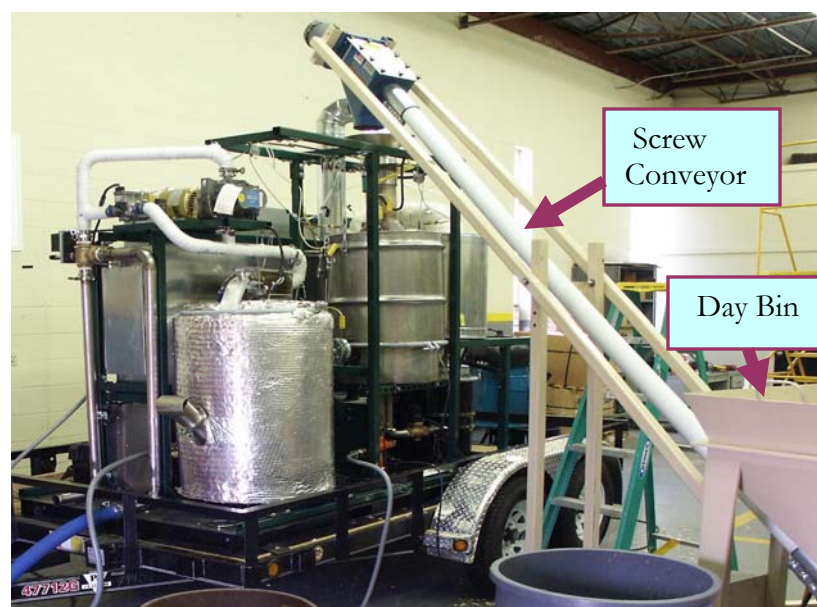

Photo 4-3: Screw Feeder of Gasifier System

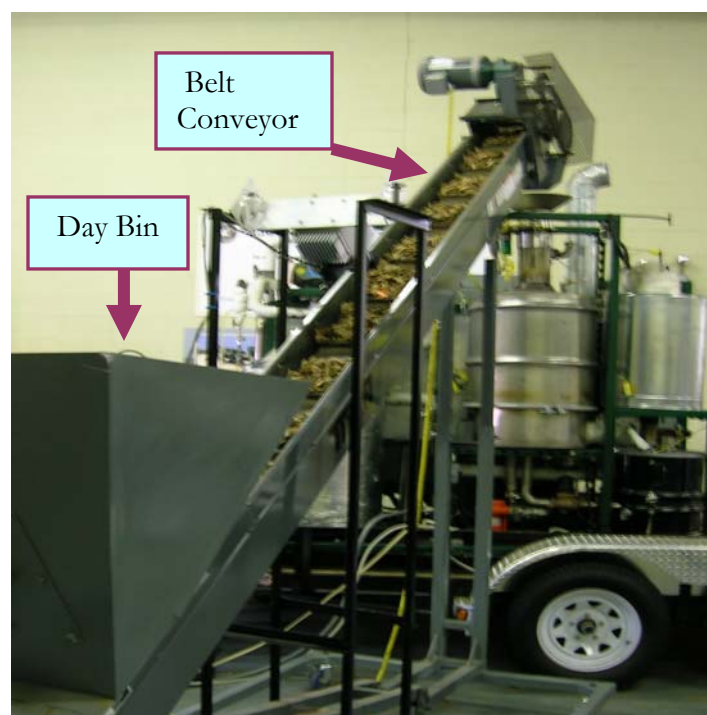

Photo 4-4: Belt Conveyor of Gasifier System

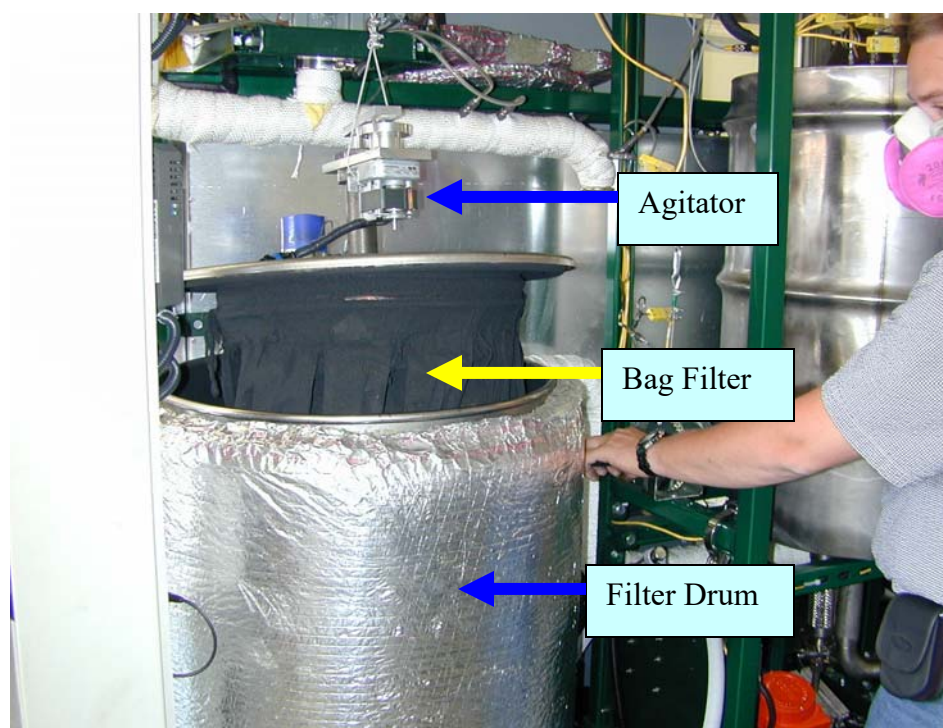

Photo 4-5: Bag Filter of Gasifier System

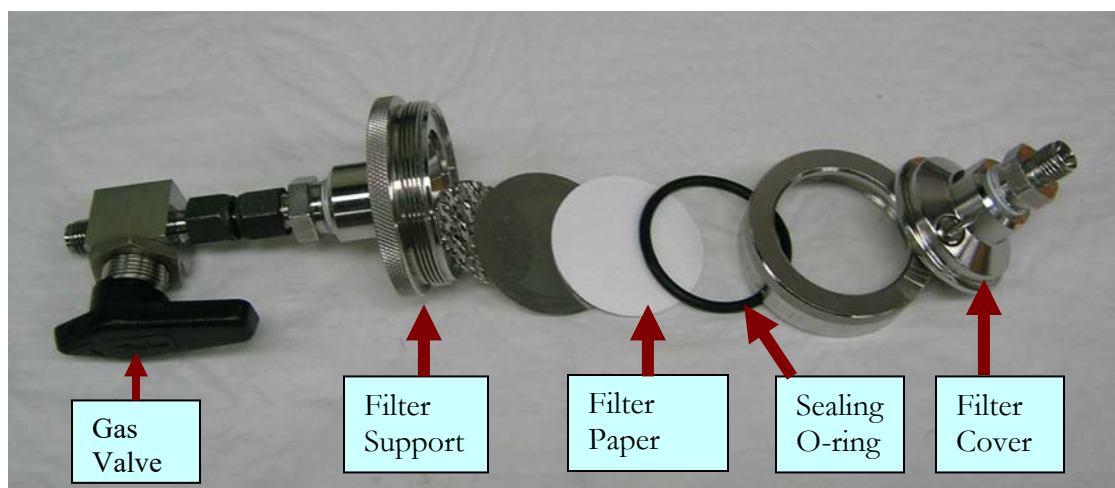

Photo 4-6: Assembly of Sampling Syn-gas Filter Holder

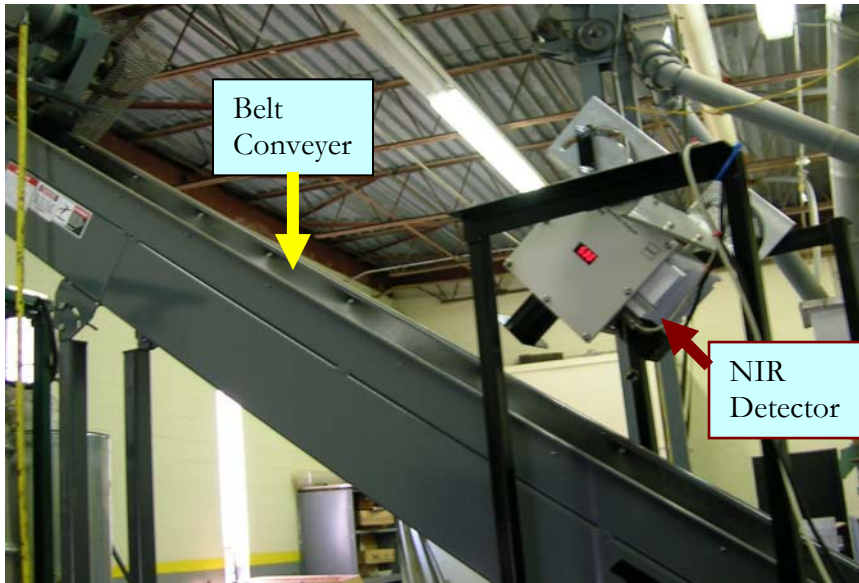

Photo 4-7: Near Inferred Detector of Moisture Content Meter

CHAPTER V

RESULTS AND DISCUSSION

In this section, the operation of the RFGG is discussed. The results of the experiments for syn-gas quality and the CR of hardwood chips are also presented. Then the suitability of syn-gas as a fuel source for ICE use is considered. Finally, the effects of the operational parameters on the syn-gas quality and the CR of hardwood chips are discussed.

5.1 RFGG System Operation Analysis

To present results about the operation of the RFGG and the effects of variation in operating parameters, an analysis of the performance of the RFGG is necessary. This analysis was conducted by examining each unit operation of the RFGG as discussed in this section.

5.1.1 Feed Unit Operation

As mentioned previously, due to problems with the screw conveyer, it was replaced with a belt conveyor. Before this however, the hardwood chips were manually fed to the gasifier during the first five runs of this study. For the rest of the runs, the

hardwood chips were automatically fed with the belt conveyer. No evident difference in performance of the RFGG as a result of the change in feeding methods was observed, and few problems occurred during feeding. One problem with the feeder unit is that the window of the bio-fuel level detector can be covered with dust from the bio-fuels. This dust occasionally made the controller act as if the gasifier chamber were full, resulting in insufficient bio-fuel in the chamber, which caused the drying zone temperatures (T1 and T2 in Figure 4-6) to go up and fire to be visible at the top of the chamber. In these cases the operation of the RFGG was halted by emergency shutdown. Accordingly, it is very important to reliably detect and control the level of bio-fuels in the chamber for gasifier performance and safety. A simple supplemental method was thus developed to detect and control the bio-fuel level in the chamber. If the control system indicated that T1 and T2 were stable at less than 100°C, and the detector indicated that the chamber was full, the detector indication was taken as true. However, if T1 and T2 were higher than 100°C, and the detector still indicated that the chamber was full, the detector indication was taken as false, and then the chamber should be manually checked. Hardwood chips bridging in the chamber could also change the temperature profile during gasification. Thus it is important to make sure that the bed vibrator of gasifier is working correctly to avoid bridging. Changing the vibrating interval or amplitude, and even manually stirring the hardwood chips in the chamber, can solve these bridging problems.

5.1.2 Gasification Chamber Control Operation

The process occurring in the gasification chamber is the most complex process in the RFGG system, because temperatures vary greatly by location and significantly with

time. Temperatures above the grate (T1, T2, T3, T4, and T5; Figure 4-6) were continuously measured and recorded by the computerized control system. Temperature averages were calculated for each run, and average temperature profiles were created. In a given temperature profile, T1 indicates the initial temperature of hardwood fed into the chamber, T2 the temperature of the drying zone in the chamber, T3 the temperature of the pyrolysis zone, T4 the temperature of the oxidation zone, and T5 (grate temperature) the temperature of the reduction zone. Variations in these temperatures during a typical test run are shown in Figure 5-1, which indicates that T5 was relatively stable during gasification, while T3 and T4 were more erratic.

As mentioned previously, the RFGG control system self-adjusts with secondary air to keep the gasifier running in a relatively stable fashion, with control based on T5. Even though the grate temperature setting of the RFGG was manually adjusted to be different among runs, the actual grate temperature (T5) always stayed within a small range. If the grate temperature setting were lowered to 750°C, the char air blower would still supply sufficient secondary air to the oxidation zone to maintain bio-fuel oxidization, releasing enough heat to keep T3 and T4 relatively high and T5 close to 800°C. If the grate temperature setting were adjusted to 850°C or 950°C, the control program again maintained T3 and T4 about at the same temperature as before and T5 close to 800°C. This self-adjusting feature of the RFGG was consistently observed during the study. Effectively, this meant that although theoretically the RFGG could be varied according to grate temperature and gas flow rate, the grate temperature setting had no strong relationship with actual grate temperature.

A total of 18 test runs including six replications each for low (750°C), medium (850°C), and high (950°C) grate temperature settings, were conducted. Comparisons between the setting and actual grate temperatures are as shown in Figure 5-2. When the grate temperature setting was 750°C, the actual average grate temperature varied from about 670 to 820°C with an average of 740°C. In only two cases was the actual grate temperature under 750°C, (615°C, and 658°C), and the average of the four higher grate temperatures was 777°C. When the grate temperature setting was 850 or 950°C, the actual average grate temperature was 785°C, with a much smaller range. Actual temperature profiles also showed no significant change during the experiments (Figure 5-3). The actual gas flow rate closely matched the value of the setting in all test runs (Figure 5-4). Since the gasification chamber of the RFGG was open to ambient air, the gas flow rate depended mainly on the power input to the Roots blower, which was controlled by the RFGG control system. When the gas flow rate was set at a high level, the power input to the Roots blower would increase, and more ambient air would be drawn into the gasification chamber to accelerate the gasification process, increasing bio-fuel throughput. Accordingly, bio-fuel would be fed into the chamber and gasified at a higher rate, and more syn-gas would be generated so that the syn-gas flow rate could closely match the set value. If a low gas flow rate were set, the power input to the Roots blower would also be low, meaning that less syn-gas would be generated, and that a low actual gas flow rate would be obtained. During normal operation, the gas flow rate was only slightly affected by other parameters such as pressure drops, and it remained stable

during the test runs. A gas flow rate curve for a typical gasification test run is shown as Figure 5-5.

The grate at the bottom of the gasification chamber could be problematic, depending on bio-fuel type, grate temperature, and gas flow rate. At times char losses in the chamber were too high, or the grate would be blocked due to ash fouling and/or clogging with un-gasified bio-fuel. In such cases, the grate required cleaning or modification. It was found that the grate needed to be cleaned after a few runs to remove the ash that had accumulated and the char that might be adhering to it. Such accumulations would result in increasing pressure drop across the gasification chamber. The RFGG would shut down if the pressure drop in the chamber got too high. Low porosity of the bulk bio-fuels, high amounts of un-gasified char particles in the chamber, or air leaks in the gasification system could also cause pressure drop problems. The source of any pressure drop problems had to be determined before associated repair or maintenance could be carried out.

Bio-fuels with higher ash contents should have shorter cleaning intervals for the grate. During this study, when the RFGG system was gasifying hardwood chips (having ash content at 0.6% of dry matter), and the actual grate temperature was under 800 °C, the cleaning interval was about 50 running hours. As a side note, preliminary gasification tests were conducted with switch-grass, having ash content up to 6.3% of dry matter. In these tests the RFGG system had to be cleaned after 5 running hours.

5.1.3 Syn-gas Separating and Cooling Unit Operation

The syn-gas separating and cooling procedure involved the char knock-out pot and the heat exchanger of the RFGG. The char knock-out pot operated trouble-free during these experiments, and the heat exchanger had few troubles during the test runs. The heat exchanger had to be cleaned when the ash and tar accumulated on the walls of the cooling pipes, leading to reduced cooling efficiency. The cleaning interval for the heat exchanger depends on the type and MC of the bio-fuel, the actual grate temperature, and the gas flow rate. When the RFGG was run with hardwood chips at an actual grate temperature of under 800°C in this study, the cleaning interval was again about 50 running hours.

5.1.4 Syn-gas Cleaning Unit Operation

The syn-gas cleaning procedure involved the bag filter and the agitator mechanism. The syn-gas was cleaned of tar and particulate matter in the bag filter, and the agitator was activated at a certain pressure drop level to remove the tar and particulate cake build-up on the surface of the bag filter. The agitator did not prevent a long-term build-up of pressure drop, possibly because of long-term tar or cake accumulations that could not be removed by simple agitation. It can further be seen that the pressure drop increased slightly as gas flow rate increased (Figure 5-5) in a test run. If the pressure drop reached a certain high level, the RFGG system would be automatically shut down. Such large pressure drops across the bag filter required cleaning or replacement. The lifetime of a bag filter is affected by the quality of syn-gas, bio-fuel type, gas flow rate, and temperature of syn-gas in the bag filter. An increased risk of tar condensate could occur

if syn-gas temperature was low (under 90°C). A typical example of the syn-gas temperatures at the bag filter during gasification is shown in Figure 5-6. The syn-gas cleaning unit was effective for particulate removal under the conditions in this study. On average, 96% of particulates in the syn-gas were removed by the bag filter. Photo 5-1 shows an example of sample filter papers from the pre-filter and post-filter syn-gas streams. In contrast, the bag filter was less effective for tar removal, which was accomplished mainly through tar deposition on particulates removed by the bag filter. On average, only 70% of the tars transported into the bag filter were removed. An example of the acetone-tar extraction solutions for pre-filter and post-filter syn-gas is shown as Photo 5-2.

5.2 Experimental Results Summary

As detailed in Table 4-4, the main portion of the study included 18 runs for two replications of the factorial experiment. Some problems were observed among these 18 runs. Although actual gas flow rates closely matched the values of the flow rate settings as described earlier, actual grate temperatures did not match grate temperature settings and varied randomly in a small range during the 18 runs. Another problem was that the MC of hardwood chips was not well controlled, as the hardwood chips were dried at ambient conditions. The MC was affected by the forced-air drying time, ambient temperatures and humidity. In the original design, the hardwood chips used in the experiments were to have been pre-treated so as to be at a consistent MC, however, the actual MC varied from 9.8 to 14.0% among runs in the main part of the experiment. Apparently due to the variation in MC, some changes in the dependent variables were

observed, such as syn-gas composition and tar and particulate contents. Therefore, it was found after the experimental runs had been conducted that the effects of MC variations on gasification should be considered. Thus, five additional runs with high MC (average 19.0%) were added for comparison. The running conditions of these five test runs are shown in Table 5-1. Additionally, two other runs were conducted at the end of this study to investigate the time distribution of MC as measured with the NIR moisture meter described in Chapter 4. These two runs were not considered in the data analysis for the factorial experiments but were used to analyze only the time distribution of bio-fuel MC.

A total of 23 runs for hardwood chip gasification were conducted in the factorial experimental study. The actual running conditions compared with original setting conditions are given in Table 5-2. The LHV and composition of syn-gas for each run are listed in Table 5-3. The averages of tar and particulate concentrations for each run are presented in Table 5-4. The averages of CR, FR, and RR for each run are presented in Table 5-5.

Table 5-1: Randomized Experimental Running Order for Supplemental Test Runs

Run No.	Gas Flow Rate (Nm ³ /h)	Grate Temperature (°C)	MC%
1	45	950	23.30
2	45	750	18.83
3	55	950	17.73
4	45	850	17.91
5	45	850	17.1

Table 5-2: Summary of Actual Running Conditions and Setting Conditions

Run No.	Setting value		Actual value		Actual value
	Gas flow rate	Grate temperature	Gas flow rate	Grate temperature	MC
	Nm ³ /h	°C	Nm ³ /h	°C	%
1	55	850	56.00	810.15	11.40
2	35	850	36.03	808.83	12.97
3	35	750	36.03	615.00	13.35
4	55	850	55.75	788.62	12.29
5	45	950	46.12	782.55	13.40
6	55	950	56.12	784.81	12.23
7	45	750	46.00	771.64	12.27
8	35	850	35.97	747.86	13.70
9	35	750	35.99	750.53	13.34
10	55	750	56.09	790.35	13.89
11	35	950	35.96	783.39	10.56
12	45	850	46.00	802.29	9.89
13	45	750	46.04	817.14	10.10
14	45	850	46.05	789.81	10.05
15	35	950	36.02	811.41	9.94
16	55	950	56.05	780.70	9.80
17	55	750	56.06	757.37	10.50
18	45	950	46.04	759.71	9.85
19	45	950	45.94	774.59	23.30
20	45	750	45.97	658.14	18.83
21	55	950	56.00	787.61	17.73
22	45	850	46.03	776.52	17.91
23	45	850	46.06	753.39	17.1

Table 5-3: Summary of Low Heating Value and Compositions of Syn-gas

Run No.	CO % (Vol.)	CH ₄ % (Vol.)	H ₂ % (Vol.)	CO ₂ % (Vol.)	LHV MJ/Nm ³
1	24.41	2.10	18.28	11.84	5.80
2	22.80	2.55	17.67	12.84	5.70
3	18.59	1.64	15.52	10.24	4.61
4	20.60	1.59	15.06	9.59	4.79
5	20.68	3.41	18.14	13.65	5.79
6	22.14	2.82	18.15	12.42	5.76
7	19.00	4.20	16.10	14.30	5.64
8	23.09	3.63	17.83	11.89	6.14
9	22.02	3.18	17.06	12.24	5.76
10	24.16	2.87	17.56	11.34	5.97
11	25.77	2.78	17.53	11.14	6.14
12	24.64	3.31	17.58	11.49	6.19
13	23.02	3.91	17.14	12.43	6.15
14	23.76	3.10	19.12	10.96	6.17
15	25.30	3.88	18.48	11.06	6.58
16	24.15	2.90	18.81	10.87	6.12
17	23.79	3.88	17.96	11.09	6.33
18	24.33	2.99	17.87	10.89	6.07
19	20.93	3.09	18.32	12.87	5.73
20	20.93	2.55	18.50	13.45	5.55
21	17.83	1.65	15.11	11.03	4.47
22	18.96	4.13	18.03	12.91	5.82
23	18.68	4.36	17.77	13.01	5.84
Average	22.16	3.07	17.55	11.89	5.79

Table 5-4: Summary of Tar and Particulate Contents in Pre- and Post-filter Syn-gas

Run No.	Pre-tar mg/Nm ³	Pre-particulate mg/Nm ³	Post-tar mg/Nm ³	Post-particulate mg/Nm ³
1	77.08	72.83	13.33	3.22
2	21.48	65.89	17.04	4.39
3	44.73	51.03	16.88	3.90
4	57.87	68.57	16.05	4.07
5	64.29	44.57	10.36	3.33
6	34.67	120.86	12.96	4.13
7	60.40	73.32	10.44	1.39
8	38.80	74.40	24.99	1.77
9	47.03	41.16	18.70	1.74
10	32.24	108.76	27.80	2.14
11	30.61	85.36	11.02	1.04
12	89.33	111.30	9.25	0.99
13	53.85	154.27	9.68	1.03
14	72.09	96.25	7.44	8.00
15	41.66	74.89	4.94	1.57
16	52.10	109.60	6.60	4.05
17	50.98	201.43	5.44	4.18
18	43.11	123.93	5.51	1.67
19	33.91	49.01	26.91	4.18
20	41.32	86.22	38.95	2.37
21	45.42	74.51	10.87	4.27
22	missing data	missing data	9.68	0.85
23	92.09	177.45	8.47	5.84
Average	51.14	93.89	14.06	3.05

Table 5-5: Summary of Feeding Rate, Conversion Rate, Carbon Conversion Rate, and Residue Rate

	Feeding Rate (FR)	Conversion Rate (CR)	Carbon Conversion Rate (CCR)	Residue Rate (RR)
Run No.	Kg/ h	Nm ³ /kg	% (Weight)	%, Weight
1	23.36	2.70	97.95	0.72
2	17.30	2.51	96.04	0.82
3	19.08	2.63	98.37	1.10
4	23.78	2.53	97.99	0.54
5	22.73	2.19	98.88	0.93
6	24.80	2.33	98.12	1.92
7	22.69	2.25	98.47	0.76
8	21.31	2.16	97.53	1.03
9	20.45	2.38	94.81	0.58
10	23.81	2.52	97.51	0.88
11	20.25	2.45	97.22	0.88
12	21.13	2.57	98.21	1.27
13	23.33	2.38	97.65	2.69
14	20.58	2.48	98.36	1.42
15	21.63	2.05	98.52	1.33
16	24.73	2.38	98.39	0.95
17	25.68	2.38	98.65	1.26
18	19.86	2.59	98.65	0.79
19	31.68	1.61	97.79	0.67
20	20.20	2.55	98.61	0.60
21	23.18	2.58	98.88	0.64
22	22.23	2.18	98.82	0.54
23	24.49	2.14	98.78	0.55
Average	22.53	2.37	98.01	0.99

5.3 Syn-gas Evaluation

For the 23 test runs, the grate temperature of the gasifier generally maintained an average of $782^{\circ}\text{C} \pm 20^{\circ}\text{C}$. The reason for the lack of variability relates to the set point control issue described in section 5.1.2. The actual average gas flow rates were 36 ± 0.13 , 46 ± 0.05 , and 56 ± 0.11 Nm^3/h for the low, medium, and high levels. The MC of the hardwood chips ranged from 9.8 to 23.3%. The total consumption of hardwood chips for this study was 1030.4 kg. Among the runs, feeding rates ranged from 17.3 to 31.6 kg/h.

The average yields of measured syn-gas components are listed in Table 5-6. A comparison with data in other published research on similar gasifier systems (Heesch et al., 1999) is presented in Table 5-7. It is apparent that the quality of post-filter syn-gas in this study compares favorably with that of syn-gas reported in the literature; combustible gas levels and LHV are in the high end of the reported range, while tar and particulate concentrations are very low. An important result of this study is that the tar and particulate contents in the produced syn-gas are significantly lower than those of syn-gas produced by other gasifier system types (Table 5-8, Graham and Bain, 1993; Neeft, et al, 1999; and Stevens, 2001).

Another comparison (Table 5-9) was performed between the post-filter syn-gas from this study and published acceptable tolerances of quality for syn-gas used as a fuel source for ICE use (FAO, 1986; Tiedema et al, 1983; Stergarsek, 2004; and Heesch et al, 1999). The syn-gas produced in this study is clearly well-suited for use as a fuel for ICEs. Based on these comparisons, it can be concluded that the post-filter syn-gas produced

from the gasification of hardwood chips with the RFGG system is of good quality regarding the measured parameters, and it could be directly used as a fuel source for ICE.

Table 5-6: Average Syn-gas Properties for Overall Test Runs

Parameters	Unit	Average	Standard Deviations
Conversion rate	Nm ³ /kg	2.37	0.24
Carbon conversion rate	% (Weight)	98.01	0.96
CO	% (Vol.)	22.16	2.39
CH ₄	% (Vol.)	3.07	0.81
H ₂	% (Vol.)	17.55	1.10
CO ₂	% (Vol.)	11.89	1.17
LHV	MJ/ Nm ³	5.79	0.52
pre-tar	mg/Nm ³	51.14	18.61
pre-particulate	mg/Nm ³	93.89	42.09
post-tar	mg/Nm ³	14.06	8.54
post-particulate	mg/Nm ³	3.05	1.79
char and ash residue	% (weight)	0.99	0.50

Table 5-7: Comparison of Syn-gas Quality with Published and Tested Data

Parameters	Unit	Downdraft Gasifier	RFGG System	Standard Deviation
		Published Data	Average Overall	
CO	% (Vol.)	10-22	22.16	2.39
CH ₄	% (Vol.)	1-5	3.07	0.81
H ₂	% (Vol.)	15-21	17.55	1.10
CO ₂	% (Vol.)	11-13	11.89	1.17
LHV	MJ/ Nm ³	4.0-5.6	5.79	0.52
Tars	mg/Nm ³	10 - 6000	14.06	8.54
Particulates	mg/Nm ³	100 - 8000	3.05	1.79

Table 5-8: Comparison of Particulate and Tar Content Representative Ranges for Different Type Gasifiers

Gasifier Type	Particulate (mg/Nm ³)	Tar (mg/Nm ³)
RFGG system	1 – 10	3 - 30
Updraft	100 -1000	20000 - 100000
Fluidized-bed	2000 - 20000	1000 - 15000
Circulating Fluidized-bed	10000 - 35000	1000 - 15000

Note: the representative range is presented as qualitative comparison of emissions from different gasifier types. Measurements are from selected facilities and may not be representative of all gasifiers in a particular class. Actual emissions from any specific gasifier depend on many factors and must be under steady-state operating conditions. (Graham and Bain, 1993)

Table 5-9: Comparison of Requirements of Engine Use and Test Data

Syn-gas Parameters	Unit	Published Data Acceptable Tolerances	RFGG Data Average Overall Runs	Standard Deviations
LHV	MJ/ Nm ³	Greater than 4.2	5.79	0.52
Tars	mg/Nm ³	Lower than 50	14.06	8.54
Particulates	mg/Nm ³	Lower than 50	3.05	1.79

5.4 Biomass Conversion Rate Analysis

To examine CR, two methods for calculation and analysis were applied in this study. First, amount of syn-gas yield per unit weight of bio-fuel was estimated. The average for all runs was 2.37 ± 0.24 Nm³ of syn-gas per kilogram of hardwood chips. Furthermore, CCR and RR were estimated. Based on the amounts of carbon from the hardwood chips and the carbon residue in the gasifier, CCR was computed. The average

CCR was $98.01 \pm 0.24\%$ by weight, and the average of RR was only $0.99 \pm 0.50\%$ by weight. For comparison, CCR was also calculated according to the amounts of carbon in the hardwood chips and the carbon converted into syn-gas. An average of $101.83 \pm 5.14\%$ by weight was obtained. The difference between the two results may be from errors in the syn-gas flow rate measurement, the syn-gas composition measurement, or omission of small carbon sources. On the other hand, the CCRs were fairly close considering the different calculation methods. Taken together, these results indicate that the gasification of hardwood chips in the RFGG system was highly effective. These CCRs appear to indicate proper selection of a gasification approach and operational parameters.

Apparently, once the hardwood chips were heated above 700°C , they were easily gasified into syn-gas, because the downdraft fixed-bed structure increased their residence time in the high temperature reaction zone of the gasifier. Large molecules such as cellulose, hemi-cellulose and lignin were broken down into medium-size molecules (such as tars or oils) and char, and then the medium-size molecules were broken down into the even smaller molecules of CO, CO₂, H₂, and CH₄. The chars (carbon) were oxidized or reduced into CO or CO₂, respectively, and thus most of the solid carbon in the hardwood chips was converted into gas-phase carbon.

5.5 Analysis of Operational Parameter Effects

In the original experimental plan, it was desired to control gas flow rate and grate temperature at specific set points for this study. These set points were selected to maintain each point at equal distances between increments as required by the statistical

method being used. Unfortunately, as discussed previously in section 5.2, since the grate temperatures and the MC of hardwood chips were not controlled, they were treated as random variables after the fact. The factorial model was thus changed to have only one independent variable (gas flow rate) and two random variables (grate temperature and MC). The relationships between these random and independent variables and the dependent variables can be represented loosely as in Figure 5-7.

For this experimental model, a set of mathematical functions, f_u , describes the relationships between the responses of dependent variables (y_h) and the independent (ξ_p) and random variables (ε_v). These relationships can be represented as follows:

$$y_h = f_u(\xi_p) \quad (5-6)$$

For each dependent variable (y_h) in a test run, the yield response of a dependent variable can be described with following model (Petersen, 1985):

$$y_{ij} = \mu + \alpha_i + \varepsilon_{ij} \quad (5-7)$$

Where

- y_{ij} = the dependent variable yield at the j_{th} treatment in the i_{th} replication.
- μ = overall mean yield.
- α_j = the effect of the j_{th} treatment measured as a deviation from μ .
- ε_{ij} = the random error associated with the j_{th} treatment in i_{th} replication.

The effects of grate temperature, gas flow rate, and MC of hardwood chips on the gasification process can be analyzed by using the equations as described above, but the

variables must be assumed as independent, so that they can be analyzed separately. The details of this analysis are presented in the following sections.

5.5.1 Effects of Grate Temperature

Again, while grate temperatures settings were 750, 850 and 950°C, actual grate temperatures were uncontrolled and ranged from 615 to 817°C among the 23 test runs, with almost all ranging from 747 to 817°C, with only two runs (at 615 and 658°C) out of this range. An analysis was conducted to examine the effects of grate temperature, treated as an independent variable, on syn-gas quality and CR of hardwood chips by including runs with grate temperatures in the range of 747 to 817°C. The two test runs with grate temperatures of 615 and 658°C were not considered, as they were anomalous and well below desired operating levels. The relationships between dependent variables and grate temperature are illustrated in Figures 5-8 to 5-12.

It can be seen in Figure 5-8 that there are no substantial differences in syn-gas composition associated with variation in grate temperature in the range of 747 to 817°C, except that CO appeared to have a slight increasing trend as grate temperature increased. This apparent trend is probably due to more oxidation of carbon particles or cracking of tars into CO as grate temperature increased. In Figure 5-9, one can find that the LHV of syn-gas has large deviations among replications, but there was no evident pattern associated with variation in grate temperature among different runs, indicating that the deviations must be caused by other factors. Figure 5-10 shows that there were also no substantial changes in CR related to variations in grate temperature. Since CR was

measured only for an entire test run, no deviations are shown in Figure 5-10. Large differences in tar and particulate contents of pre-filter syn-gas existed among runs (Figure 5-11), but the differences have no apparent trend or pattern. Tar and particulate concentrations in post-filter syn-gas were also quite different among different runs, but again no significant pattern was found (Figure 5-12). The differences noted may have been caused by other factors acting as random effects on these parameters, but they do not appear to be due to variations in grate temperature from 747 to 817°C.

However, as noted earlier, previous investigations have indicated that syn-gas yield and quality were significantly affected by reactor temperatures, which can be represented as the temperature profile of the gasifier. Again, Figure 5-3 indicates that the RFGG's self-adjusting capability kept the reactor temperature profiles relatively stable by controlling the grate temperature at around 800°C. Therefore, it appears that the primary reason for the lack of a relationship to grate temperature is that the RFGG functions as a strongly self-adjusting control system to keep the gasifier running at relatively stable conditions. Even though the operator sometimes set the grate temperature lower or higher, actual grate temperatures were not significantly different from 800°C. Fairly stable grate temperatures resulted in fairly stable reaction temperatures in the RFGG system. Furthermore, while there was some variation in average temperature (747 to 817°C) among the runs considered in this analysis, the entire range was 60°C instead of the 200°C (750 to 950°C) intended in the experimental design, making it much harder to detect any significant random temperature effects.

Another reason for lack of a temperature effect is that the gasification chamber was open to ambient air, which allowed the operator no control over air-to-fuel ratio. As noted previously, the control system automatically controlled the air ratio at a relatively steady state. With reaction temperature and air ratio relatively stable, the gasification process could be expected to be stable, and this appears to be how the RFGG was designed by CPC. The yield, composition, and LHV of the syn-gas, and the bio-fuel CR experienced no significant changes. All these output parameters could be expected to fluctuate if air-to-fuel ratio and reactor temperature profile fluctuated significantly.

5.5.2 Effects of Gas Flow Rate

The gas flow rates were set at low (35 Nm³/h), medium (45 Nm³/h), and high (55 Nm³/h) levels in the experiments. Actual gas flow rates closely resembled the values set by the operator in all test runs (Figure 5-4). By following the statistical model described in section 5.4, SAS software was used to run a one-way ANOVA at the $\alpha = 0.05$ level to examine the effects of gas flow rate (treated as an independent variable) on syn-gas quality and CR (treated as dependent variables), and the results are presented in Table 5-10. Details of the statistical analysis can be found in Appendix C. Responses of the dependent variables to the independent variable (gas flow rate) are presented as Figures 5-13 to 5-18.

Figures 5-13 and 5-15 show little change in the composition and LHV of syn-gas and CR of the hardwood chips as the gas flow rate increased from 36 to 56 Nm³/h. The results of statistical analysis indicated further that these differences were not significant at

the $\alpha = 0.05$ level (Table 5-9). In Figure 5-16, it can be seen that there were substantial differences in the particulate contents of pre-filter syn-gas between gas flow rates of 36 and 56 Nm³/h, but the differences were not statistically significant between 36 and 46 Nm³/h or between 46 and 56 Nm³/h. The differences might be the result of higher velocities of flowing gases and higher pressure drop in the chamber due to increased gas flow rates, leading to incomplete gasification of more char particulates that could be drawn downstream with the syn-gas. More particulates exiting the chamber would mean a significant increase in the particulate concentration in the pre-filter syn-gas. Figure 5-16 also shows that tar content in pre-filter syn-gas was substantially higher at 46 than at 36 or 56 Nm³/h. The difference between tar contents at 36 Nm³/h and 56 Nm³/h was not significant. For post-filter syn-gas, there were no statistically significant differences in either tar or particulate concentrations due to changes in gas flow rate (Figure 5-17). The lack of difference here is probably due to the fact that the bag filter effectively removed tars and particulates in the syn-gas regardless of the gas flow rate, and that the remaining levels were low enough that the measurement error obscured any trends. The reason that gas flow rate has no great effect is that, again because of the self-adjusting design of the RFGG control system, the temperature profile of the gasifier does not change significantly as gas flow rates changes in the range of 36 to 56 Nm³/h (Figure 5-18). When gas flow rate increases, the Roots blower draws more air into the gasification chamber, bio-fuel is gasified more quickly, bio-fuel is fed into the chamber more quickly, and the cooling effect of additional ambient air flow is balanced by additional heat from more rapid gasification.

Table 5-10: Statistical Analysis for the Effects of Gas Flow Rate ($\alpha = 0.05$)

Dependent Variable	F value	Effects
Conversion rate	0.58	Not Significant
CO	0.13	Not Significant
CH ₄	1.98	Not Significant
H ₂	0.14	Not Significant
CO ₂	1.44	Not Significant
Low heating value	0.29	Not Significant
Pre-tar	5.13	Significant
Pre-particulate	2.76	Significant
Post-tar	1.92	Not Significant
Post-particulate	0.73	Not Significant

5.5.3 Effects of Moisture Contents of Hardwood Chips

The actual MC of the hardwood chips varied in a range from 9.8 to 14.0% among the 18 runs in the main portion of this study. Results of the experiments indicated that these variations influenced the gasification process. Thus, five additional runs with high MC (average $19.0 \pm 2.5\%$) were added for comparison. The 23 test runs of the entire experiment were divided into four levels of MC: approximately 10 ± 0.12 , 12 ± 0.85 , 14 ± 0.32 , and $19 \pm 2.5\%$ for purposes of statistical analysis. The differences in temperature profiles related to the differences in MC are shown in Figure 5-19. When MC increased from 14% to 19%, the temperature profiles were significantly different, but there were no statistically significant differences between temperature profiles as MC varied in a small range, such as from 10% to 12% or from 12% to 14%. However, there was still a consistent trend.

SAS software was used to run a one-way ANOVA at $\alpha = 0.05$ level to examine the effects of MC (treated as an independent variable) on the syn-gas quality and CR of hardwood chips (treated as dependent variables). The results of the statistical analysis are presented in Table 5-11. The responses of the dependent variables to the independent variable are shown as Figures 5-20 through 5-24. The details of the statistical analysis can be found in Appendix D.

In Figure 5-20, it can be seen that CO content in the syn-gas significantly decreased when MC of the hardwood chips increased from 10% to 19%, while CO₂ content had a slightly increasing trend. These changes may be due to a higher heat requirement to vaporize water in the higher MC hardwood chips. Reaction temperatures were reduced when MC increased. Lower temperatures probably led to a lessening of the carbon reduction reaction, along with a decrease in the CO content. On the other hand, higher MCs apparently resulted in an increase in water vapor in the gasification chamber, increasing the level of water gas shift reactions (Equation 2-6). These reactions would result in a decrease in CO in the syn-gas while CO₂ would increase, as CO would be converted to CO₂. This scenario is a reasonable explanation as to why CO content significantly decreased when the MC of the hardwood chips increased.

From Figure 5-21, one can see that the LHVs of the syn-gas had large deviations and trended downward as MC increased. There was a statistically significant difference in LHV between high and low levels of MC. The significant decreases in the combustible CO apparently gave rise to the LHV decrease. The CR of hardwood chips also had a slightly decreasing trend as MC increased (Figure 5-22). No significant differences in tar

and particulate contents in pre-filter syn-gas were associated with the changes in MC of the hardwood chips (Figure 5-23), but tar and particulate contents had large deviations among different MC levels. In post-filter syn-gas, the tar content had a significant increasing trend as MC increased. Higher MCs apparently resulted in more tar condensation and thus higher tar content in the syn-gas. The particulate contents in post-filter syn-gas exhibited no significant changes as MC changed. The bag filter was apparently effective enough at removing particulates from syn-gas such that particulate contents were not significantly different in post-filter syn-gas whether or not they were different in pre-filter syn-gas.

The MCs were measured online with an NIR moisture meter as described in Chapter 4, to detect the time distribution of MC. It is clear in Figure 5-25 that MC was not consistent over time, as different portions of hardwood chips, apparently having different MCs, were fed into the gasifier. The average MC was determined as 17.7% during a test run during which MC ranged from 9.8 to 34% (figure 5-25). As the average MC of hardwood chips affected temperature profiles in the gasification process, large changes in MC during a run could also possibly affect the temperature profiles during gasification. The unstable temperature profile that could result from large variations in MC would apparently produce unstable syn-gas quality and CR. The effects of time distribution of MC of bio-fuels on gasification should thus be examined further in a future study.

Table 5-11: Statistical Analysis for the Effects of Moisture Content ($\alpha = 0.05$)

Dependent Variable	F value	Effects
Conversion rate	0.58	Not Significant
CO	6.37	Significant
CH ₄	0.42	Not Significant
H ₂	0.94	Not Significant
CO ₂	1.38	Not Significant
Low heating value	2.4	Significant
Pre-tar	0.88	Not Significant
Pre-particulate	1.58	Not Significant
Post-tar	3.8	Significant
Post-particulate	0.13	Not Significant

5.6 Data Quality and Error Estimation

The experimental data throughout the study contained considerable scatter. The error bars in the figures suggest that most standard errors of the parameters were less than 20% of the mean values, but some were as high as 30%, depending on the nature of the parameter concerned. The scatter and error resulted from a number of factors, such as the interactions among variables, system control and operation, systematic error in sampling, etc.

An important source of scatter is the interaction among variables. In the original factorial experimental design, the effects of and interactions among independent variables were taken into account. The design required regularly spaced variation within independent variables, but during operation some parameters were not controlled as desired. For example, grate temperature was held fairly consistently at one level (800°C) by the RFGG control system even when the operator set a different control level. Since

the experimental model of two independent variables with three levels had to be replaced by a model with one independent variable and two random variables, possible interactions between variables could possibly be ignored in the data analysis. Also, the MC of the hardwood chips was not controlled in the desired range due to a lack of drying conditions. These uncontrolled situations likely increased the random experimental error.

Another important source of scatter is random error in sampling. To collect required data, four data acquisition systems were employed. Temperature, pressure drop, and other parameters were measured directly by sensors in the RFGG. The accuracies of these data are fairly high. However, some parameters such as MC of hardwood chips, and tar and particulate contents in syn-gas, were measured manually. The measurement accuracies of these parameters can be affected by many factors. Though all meters, balances and scales used in this study were calibrated to eliminate systematic error associated with these sensors, there were still random and systematic errors in the data, depending on ambient conditions, operators, and sampling procedures. The lack of uniformity in bio-fuel MC or in the syn-gas can strongly affect sampling accuracy. For example, measuring MC of hardwood chips was affected by MC distribution during a run, sampling positions in the day bin, or sampling time and measuring procedure. Again Figure 5-25 shows that MC was uneven during the gasification process. All these factors can influence the accuracy of the MC measurement. Another example is the tar and particulate determination. The interval of collecting syn-gas samples for determining tar and particulate contents was about 30 minutes, such that it would take about 60 minutes (at 0, 30, and 60 minutes) for the three samples collected per run. The fluctuations in the

temperature profile, gas flow rate, or bio-fuel MC can also contribute to the error. Since the bag filter surface was built up with accumulation of ash and tar condensate, there were apparent differences in the tar and particulate contents in post-filter syn-gas between the third and the first samples taken during each run. This phenomenon was more evident when the MC or the ash content of bio-fuels was higher. The measurement approaches for tar and particulate separation from syn-gas samples are also critical for accurate tar and particulates content determinations. Acetone was used to wash tar from sampling filter papers. The loss of tars or fine particulates in the solutions or testing procedures could also contribute to measurement error. To eliminate these sources of error in future studies, better control of operating parameters, more accurate sampling and measurement procedures, and more sampling replications are suggested.

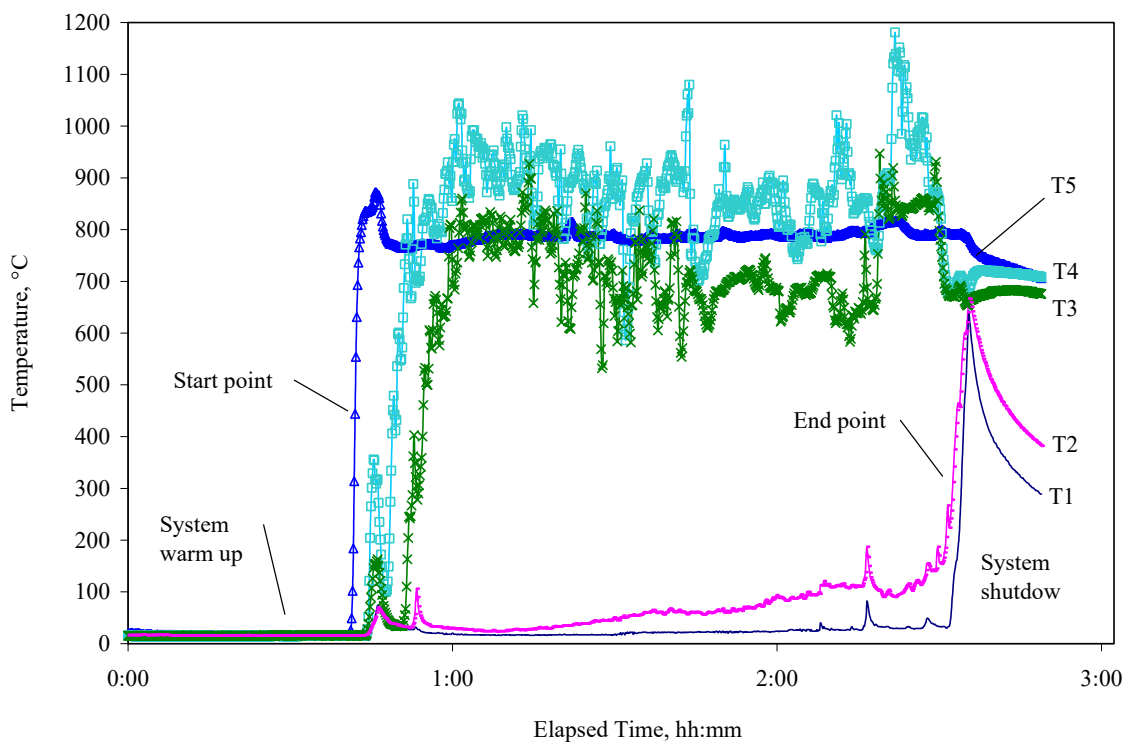

Figure 5-1: Fluctuations of Gasifier Temperatures During A Typical Run

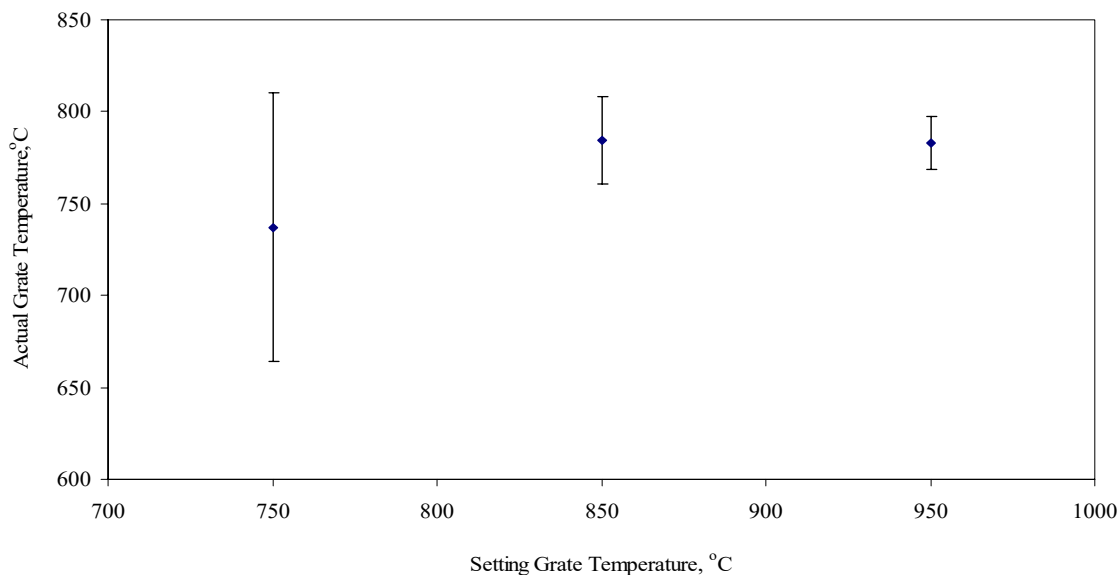

Figure 5-2: Comparison of Setting and Actual Grate Temperatures

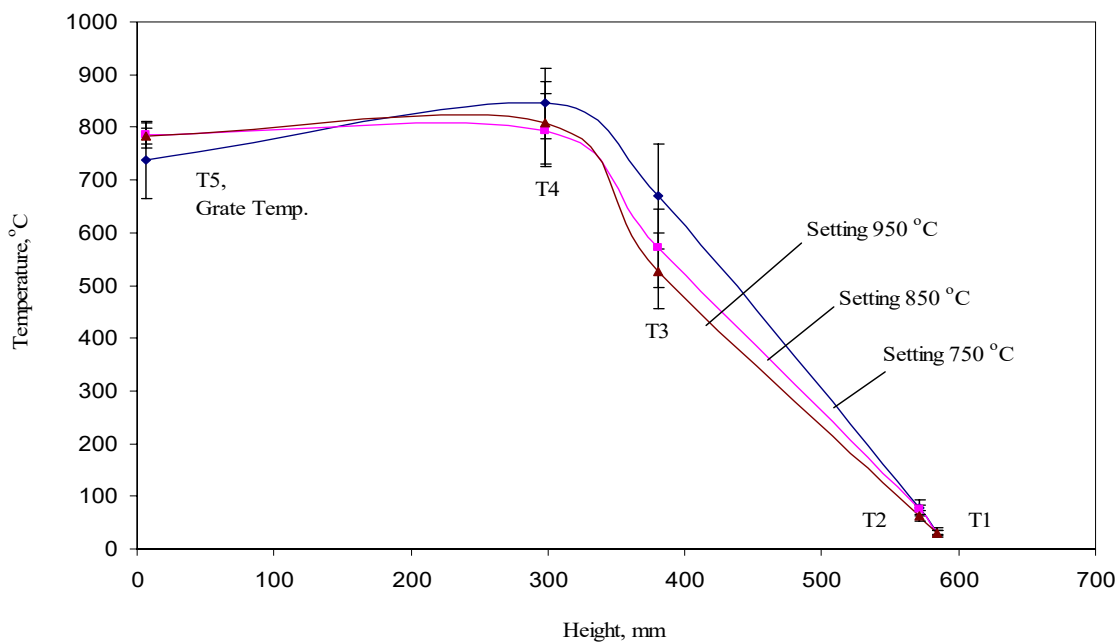

Figure 5-3: Temperature Profiles at Different Setting Grate Temperatures

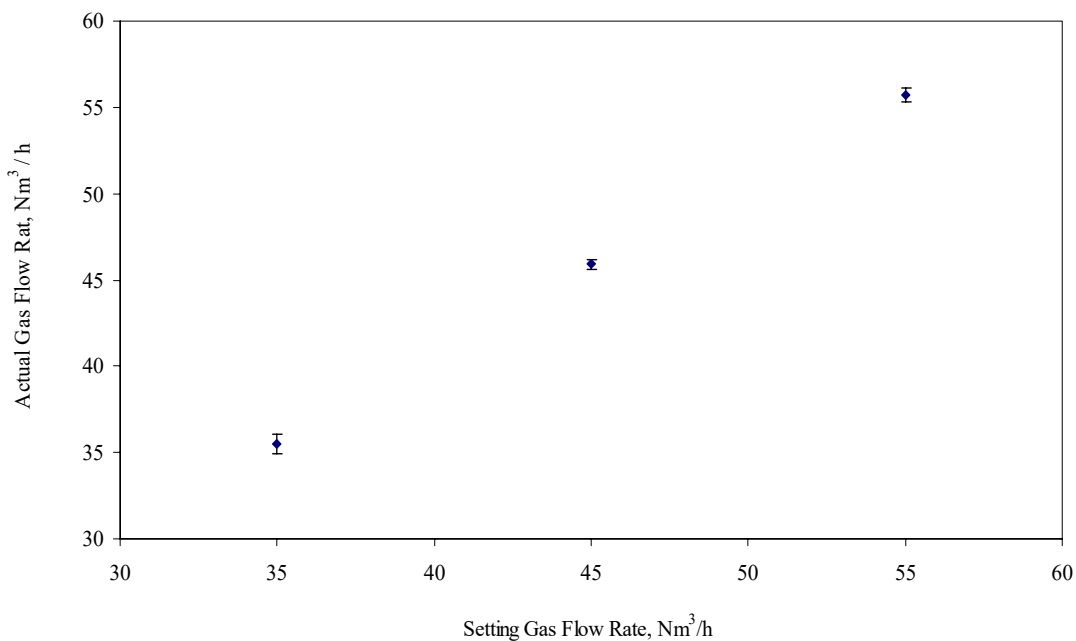

Figure 5-4: Comparison of Setting and Actual Gas Flow Rates

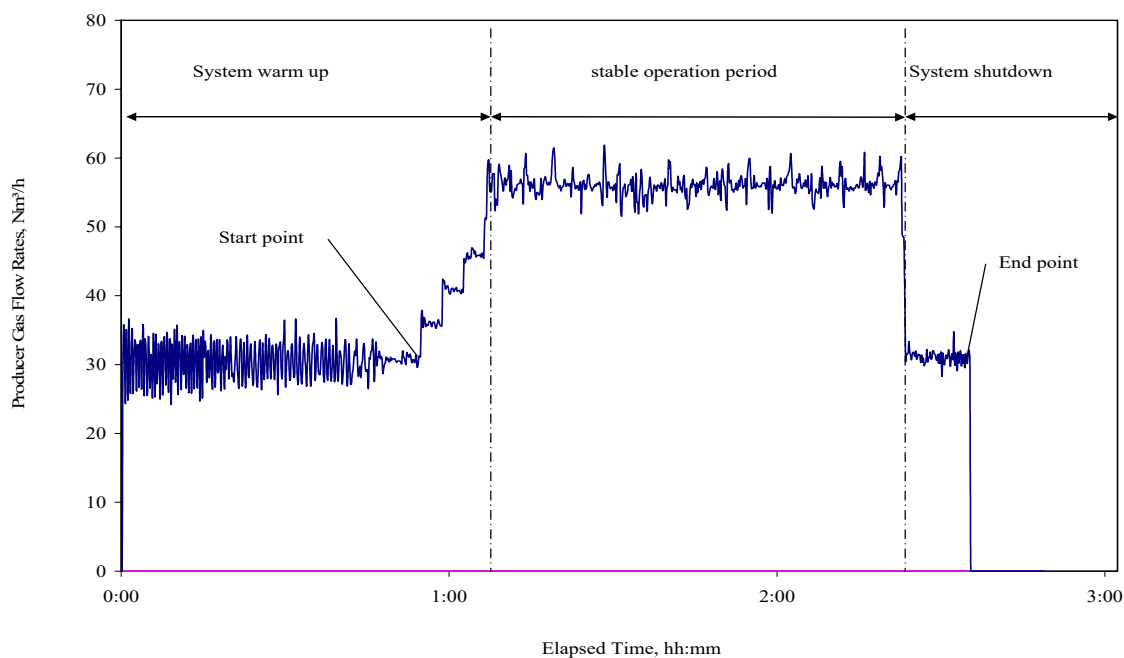

Figure 5-5: Gas Flow Rate of A Typical Test Run

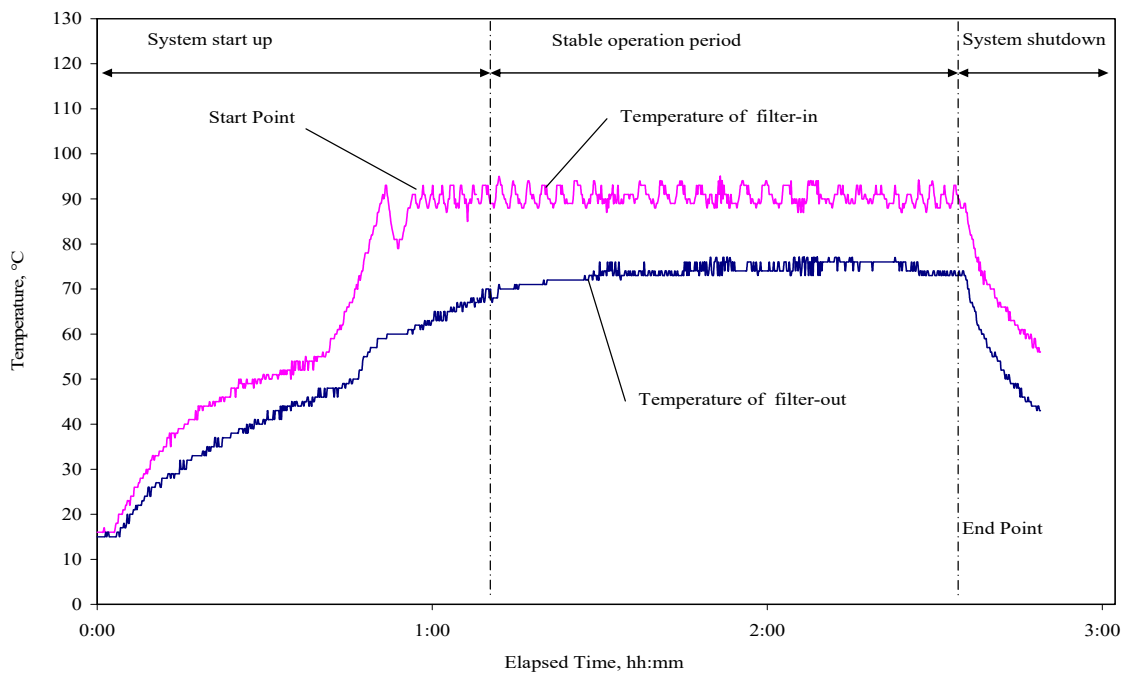

Figure 5-6: Syn-gas Temperatures in Bag Filter of A Typical Test Run

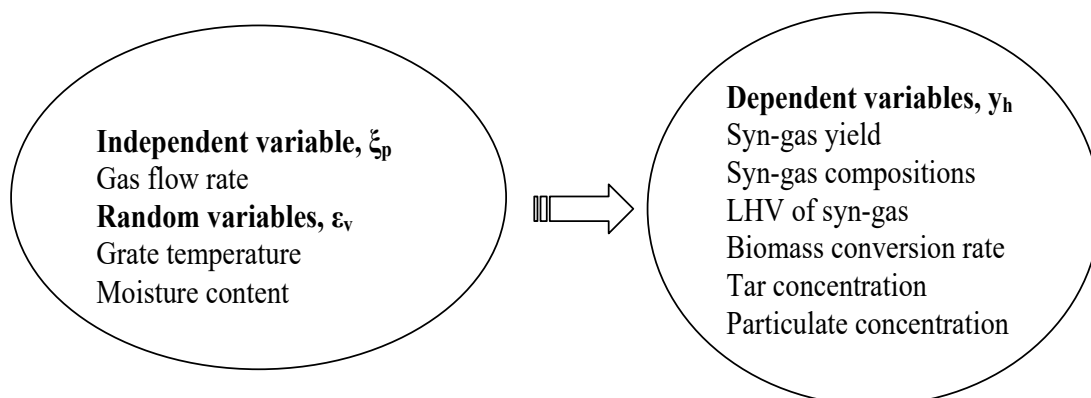

Figure 5-7: Relationships of Independent, Random, and Dependent Variables

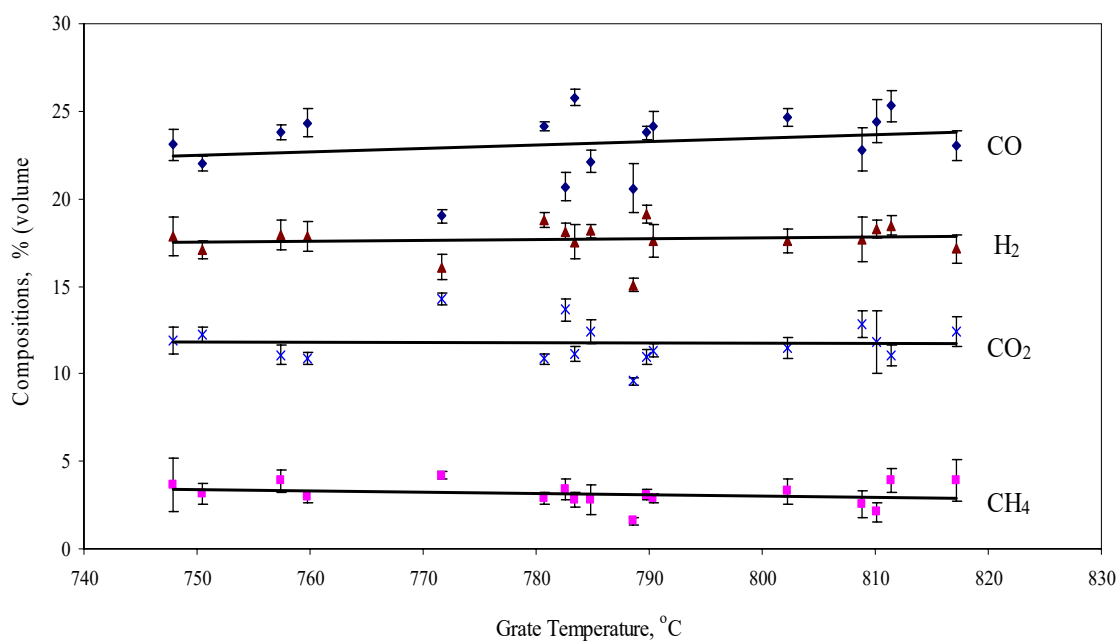

Figure 5-8: Syn-gas Compositions at Different Grate Temperatures

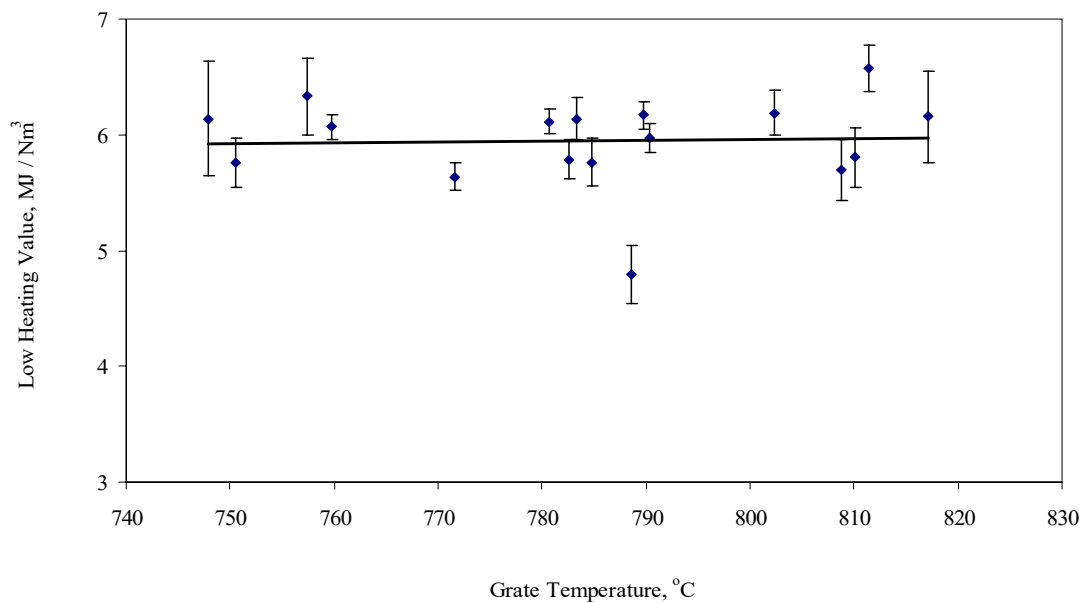

Figure 5-9: Low Heating Values of Syn-gas at Different Grate Temperatures

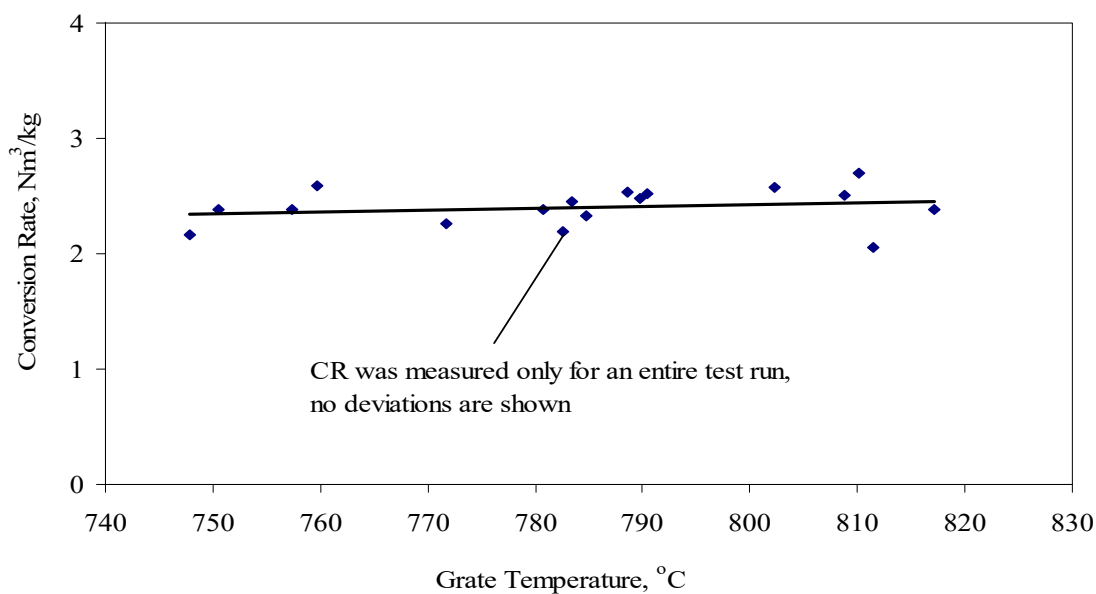

Figure 5-10: Conversion Rate of Hardwood Chips at Different Grate Temperatures

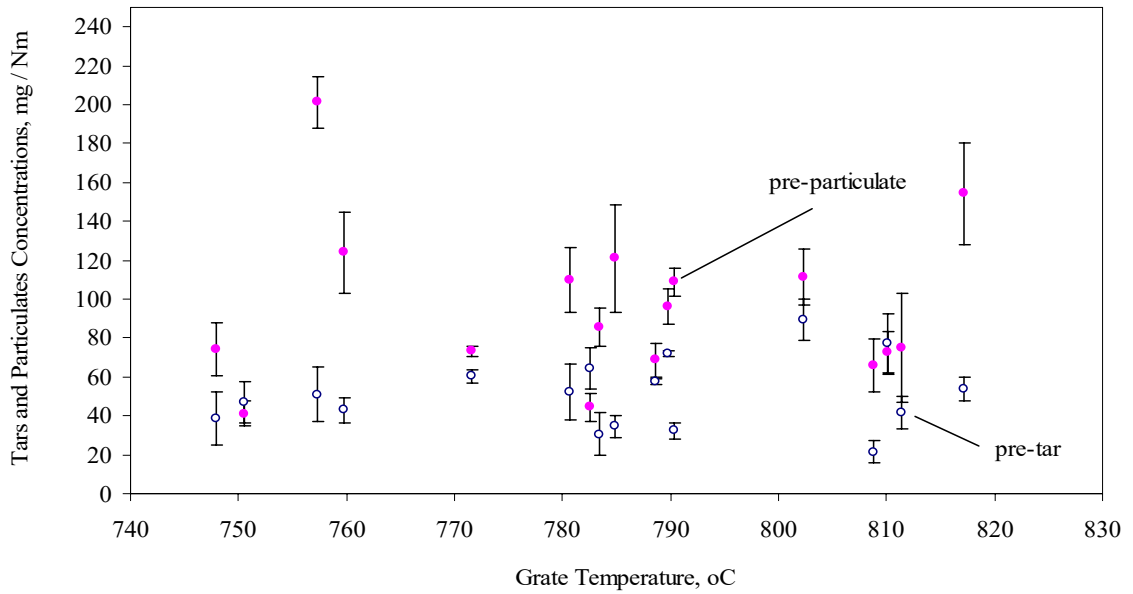

Figure 5-11: Tar and Particulate Contents in Pre-filter Syn-gas at Different Grate Temperatures

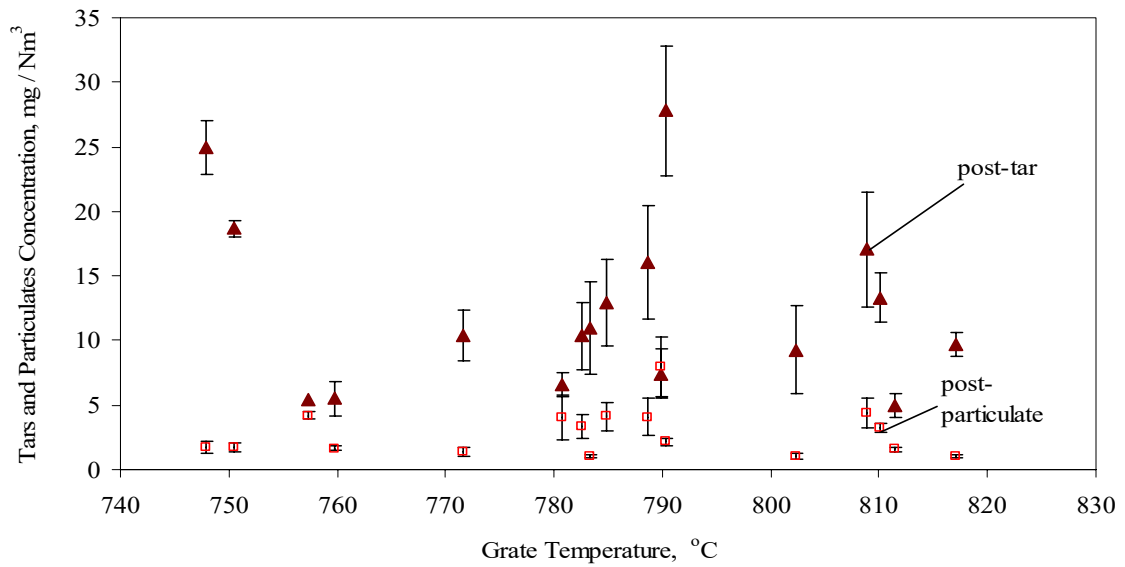

Figure 5-12: Tar and Particulate Contents in Post-filter Syn-gas at Different Grate Temperatures

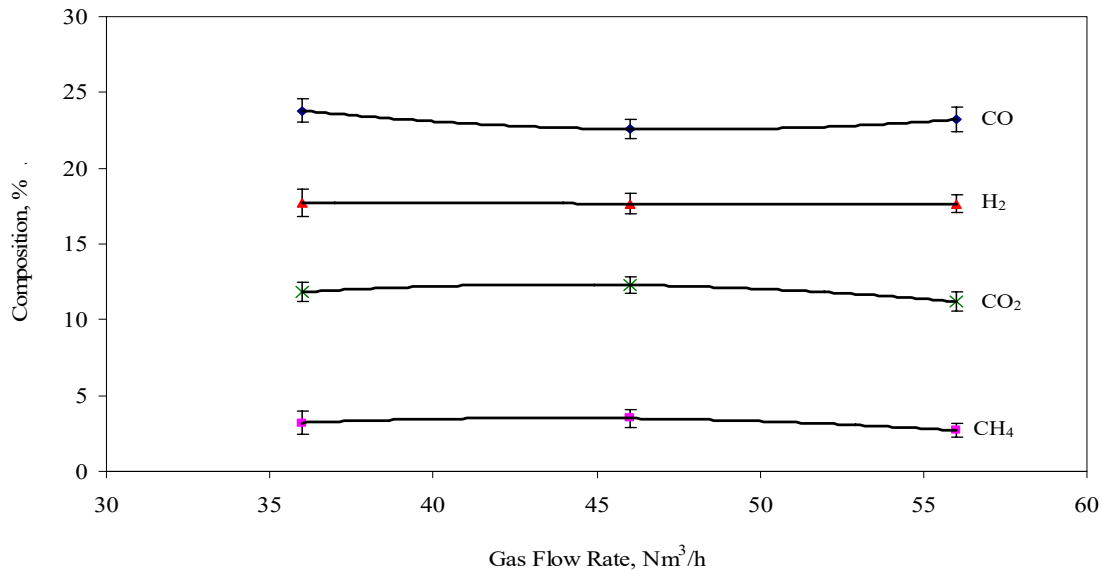

Figure 5-13: Compositions of Syn-gas at Different Gas Flow Rate

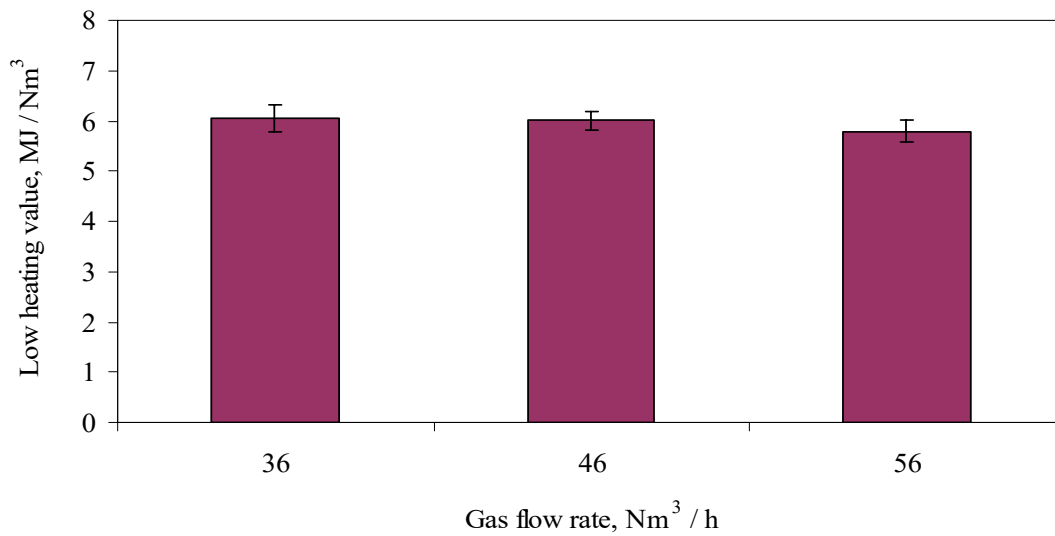

Figure 5-14: Low Heating Values of Syn-gas at Different Gas Flow Rates

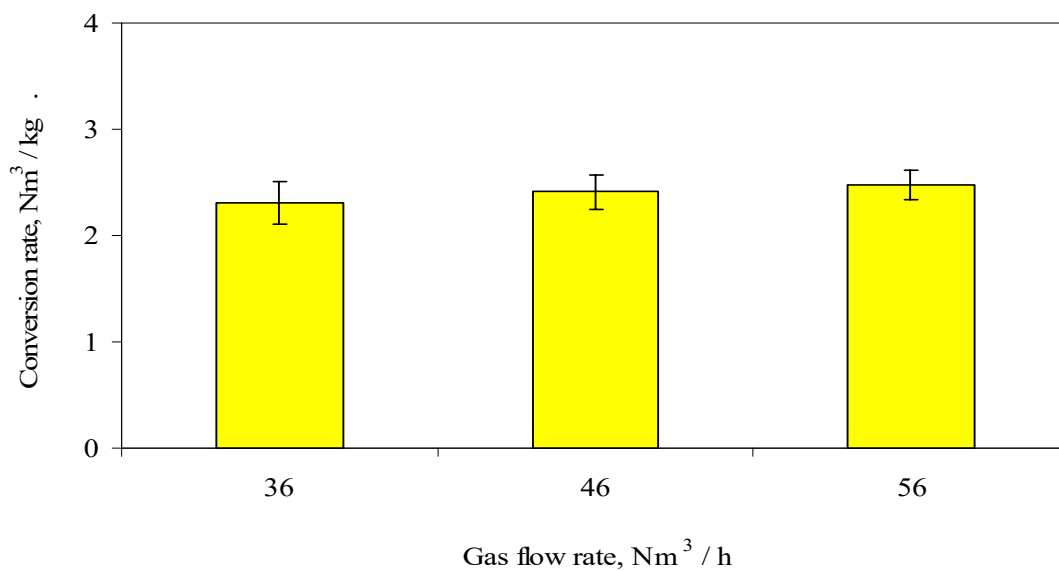

Figure 5-15: Conversion Rate of Hardwood Chips at Different Gas Flow Rates

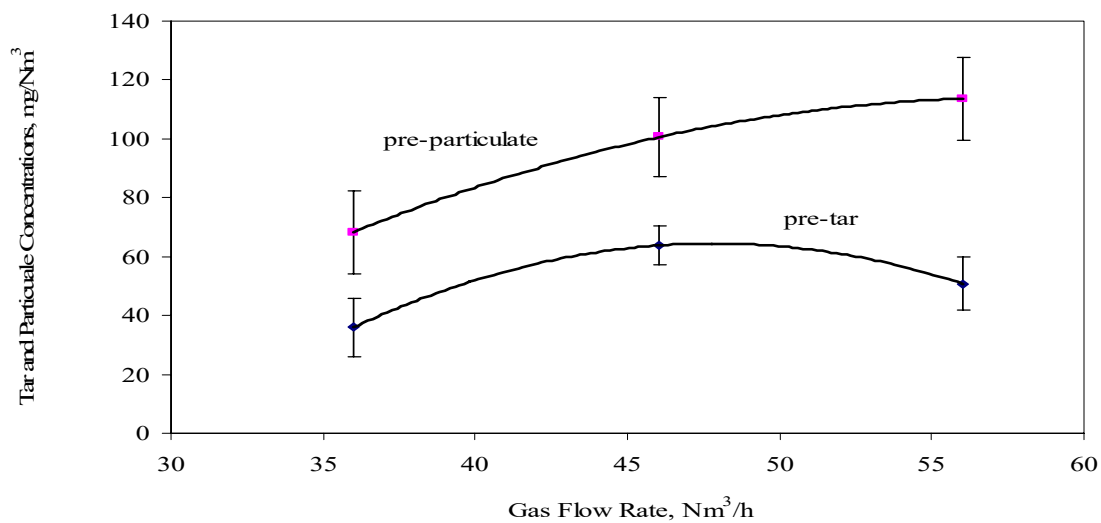

Figure 5-16: Tar and Particulate Contents in Pre-filter Syn-gas at Different Gas Flow Rates

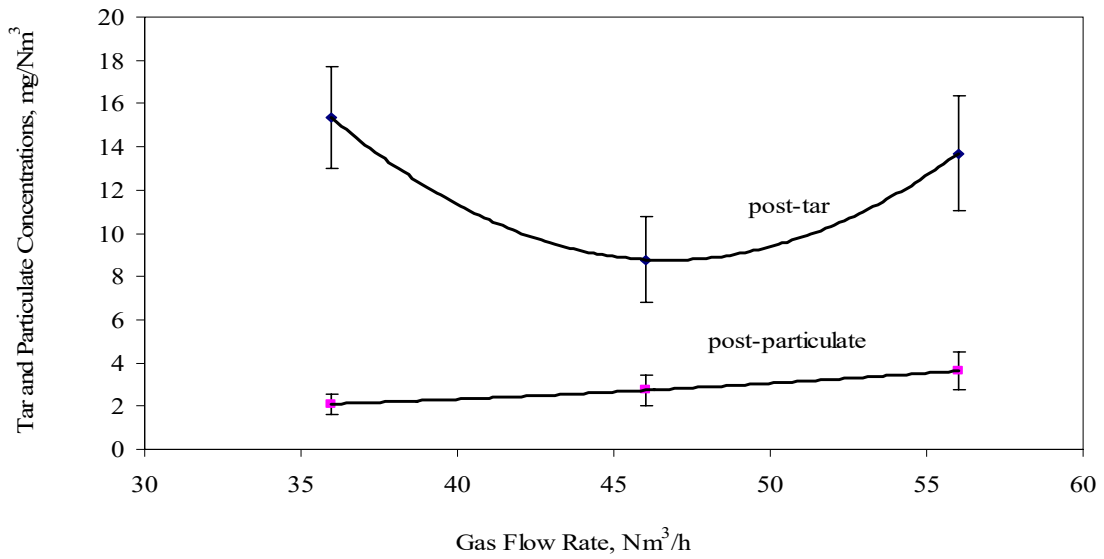

Figure 5-17: Tar and Particulate Contents in Post-filter Syn-gas at Different Gas Flow Rates

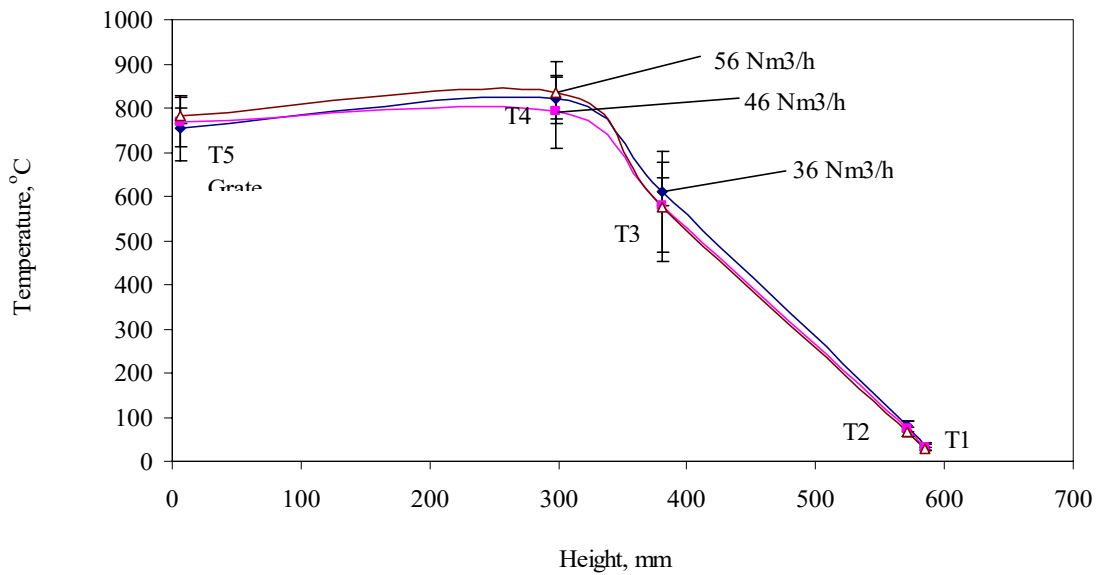

Figure 5-18: Temperature Profiles at Different Gas Flow Rates

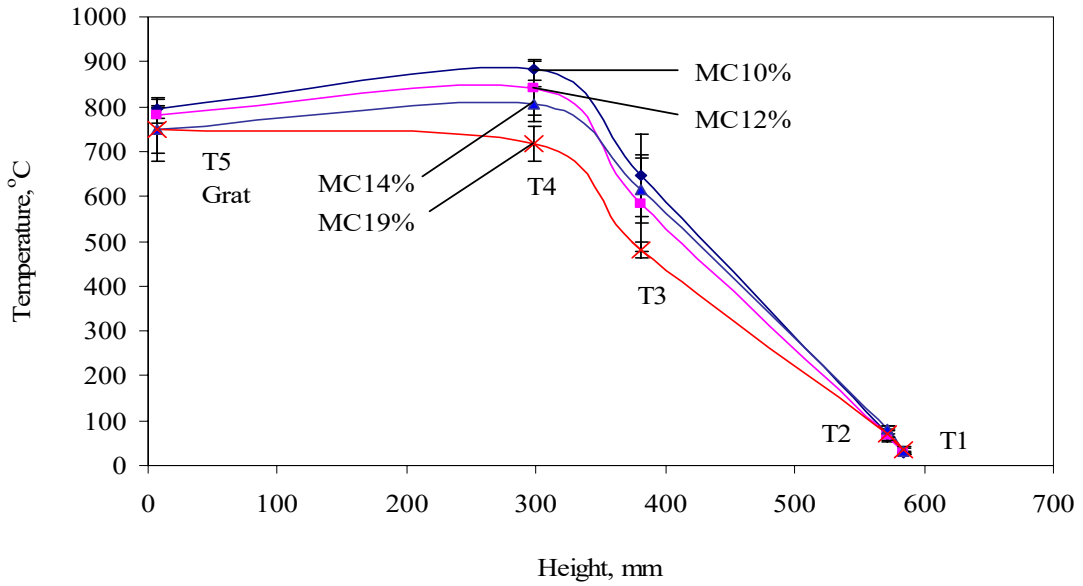

Figure 5-19: Temperature Profiles at Different Moisture Contents

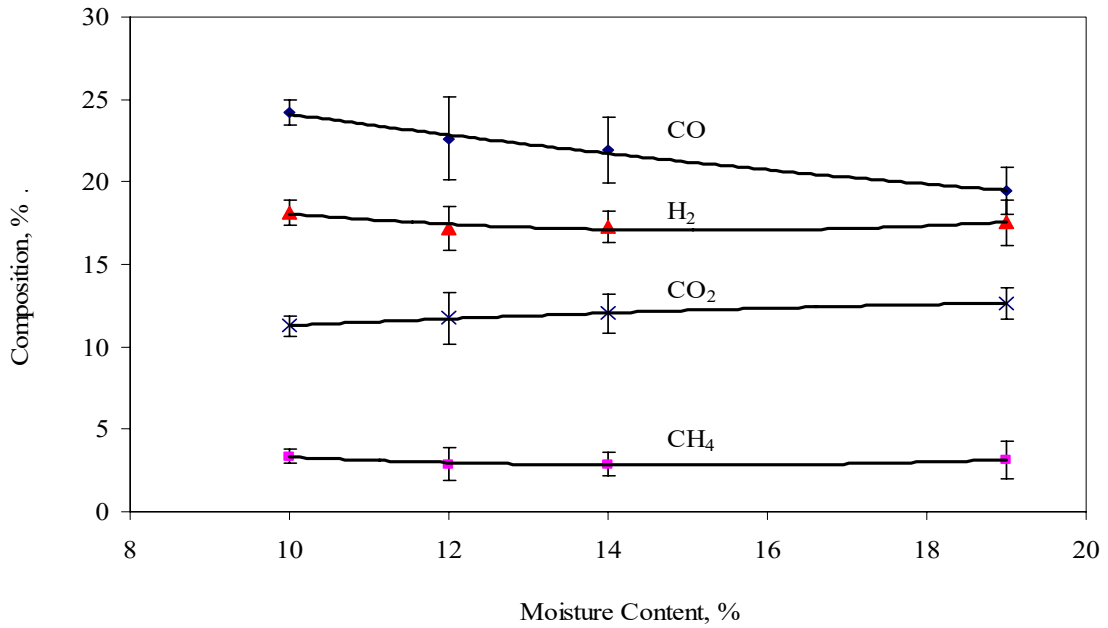

Figure 5-20: Compositions of Syn-gas at Different Moisture Contents

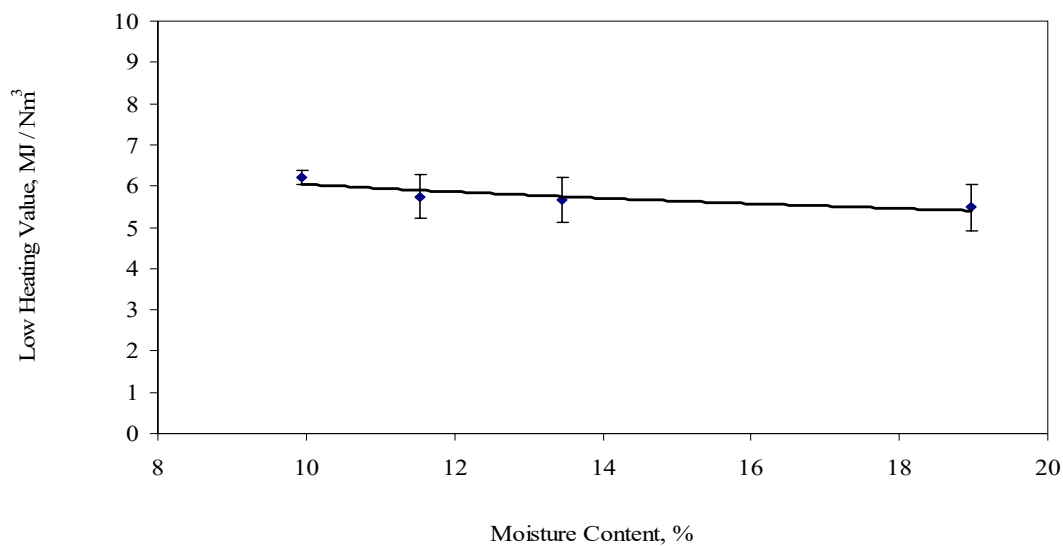

Figure 5-21: Low Heating Values of Syn-gas at Different Moisture Contents

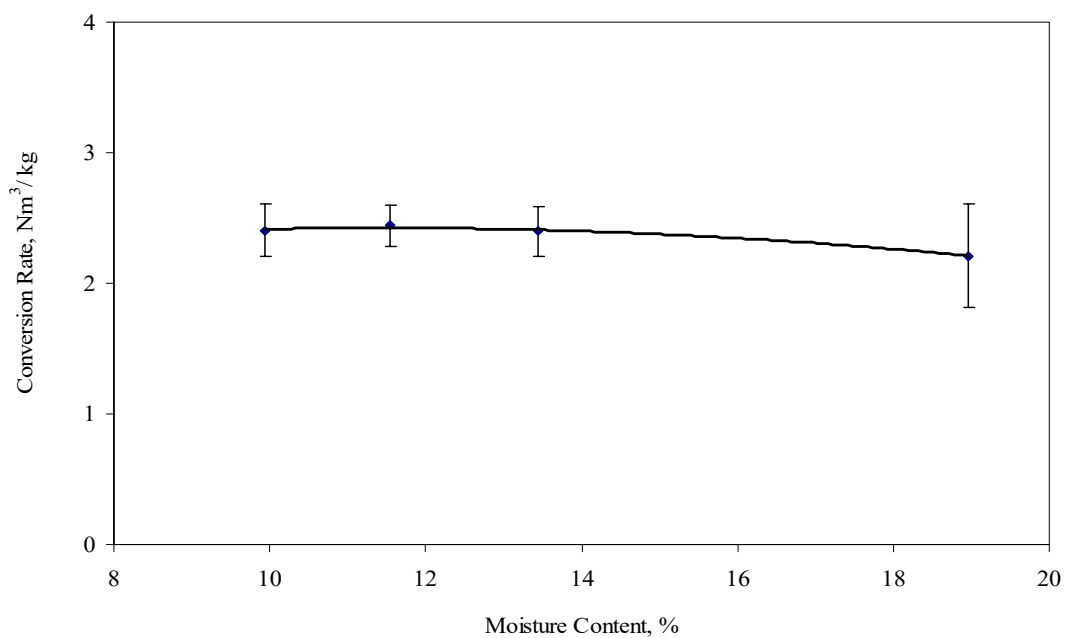

Figure 5-22: Conversion Rate of Hardwood Chips at Different Moisture Contents

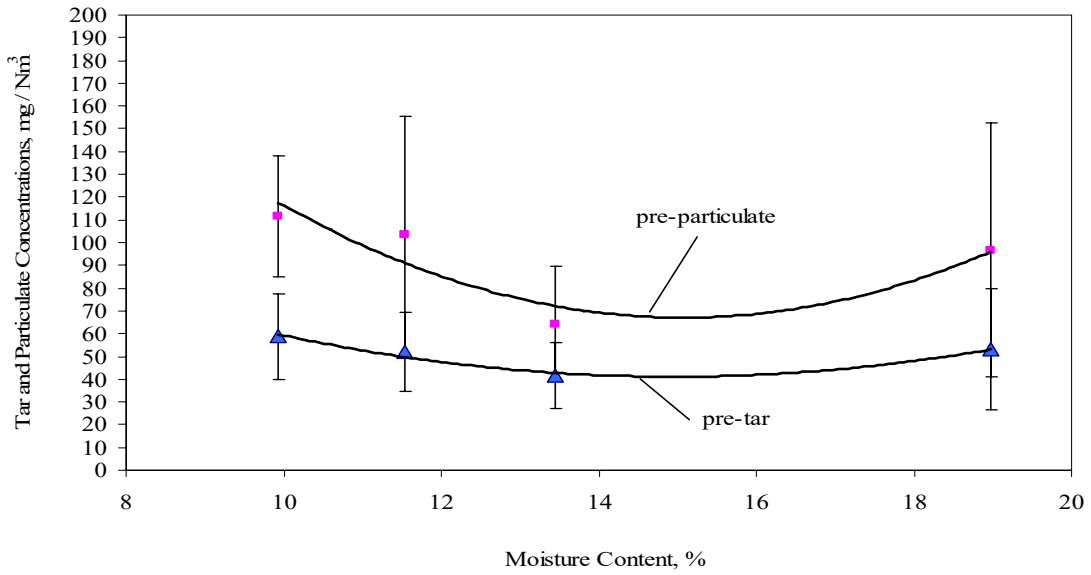

Figure 5-23: Tar and Particulate Contents in Pre-filter Syn-gas at Different Moisture Contents

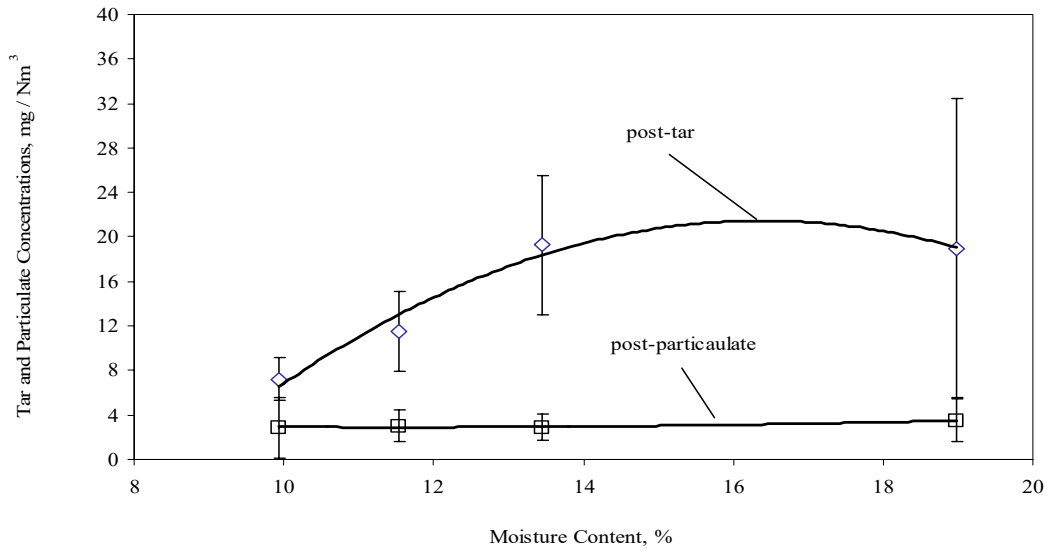

Figure 5-24: Tars and Particulate Contents in Post-filter Syn-gas at Different Moisture Contents

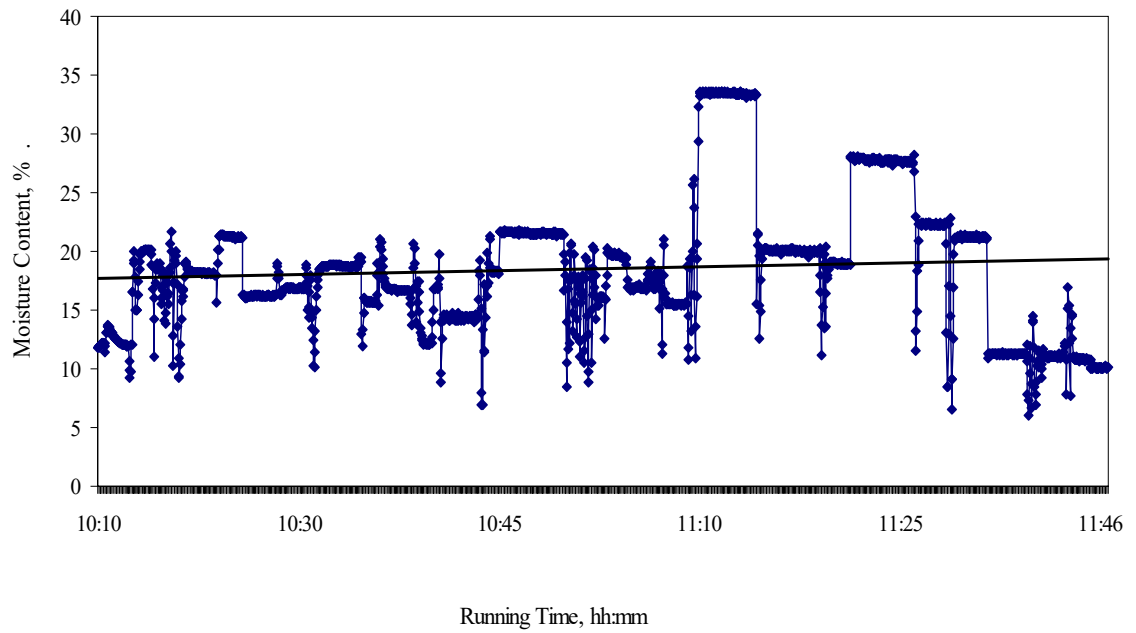

Figure 5-25: Time Distribution of Hardwood chip Moisture Content During A Typical Test Run

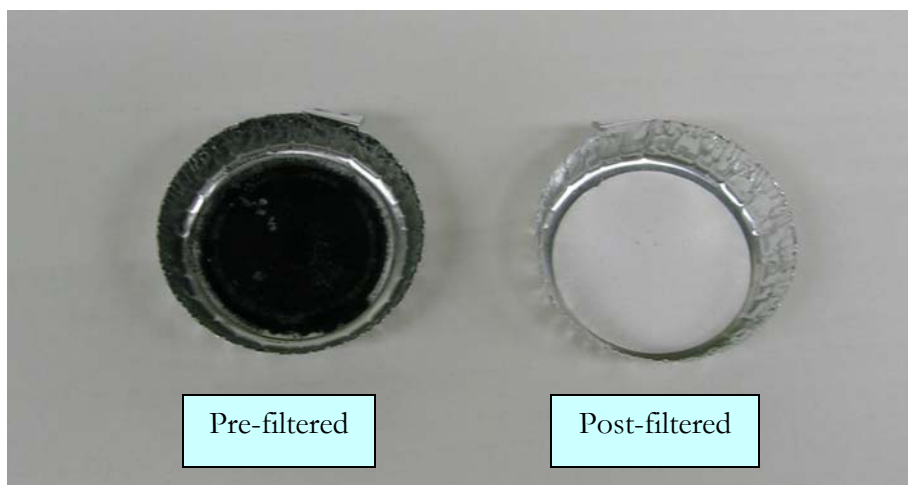

Photo 5-1: Comparisons of Pre- and Post-filtered Syn-gas Sampling Filter Papers



Photo 5-2: Comparisons of Pre- and Post-filtered Syn-gas Acetone-tar Solutions

CHAPTER VI

CONCLUSIONS AND RECOMMENDATIONS

6.1 Summary and Conclusions

Biomass gasification can be an attractive approach for power generation. Selecting proper designs and improving the performance of gasifiers are critical for producing high quality syn-gas. In this study, a total 1030 kg of hardwood chips was gasified in a pilot-scale fixed-bed downdraft gasifier (RFGG) to produce syn-gas. Experiments concerning the operation of the RFGG were conducted under various operating conditions. Composition and LHV of the syn-gas generated during the experiments was measured. Tar and particulate concentrations in pre- and post-filter syn-gas were also determined. The suitability of the syn-gas produced was assessed by comparison with available published information. A one-way ANOVA was performed for statistical analysis of the effects of gas flow rate and MC on syn-gas quality and bio-fuel CR. The following conclusions can be drawn from this experimental study.

- The RFGG is suitable for gasifying hardwood chips to produce syn-gas that has good quality with tar and particulate contents significantly lower than those of syn-gas

produced by other type gasifiers. The syn-gas can be directly used as a fuel source for ICE use.

- Grate temperatures in the range of 740 to 817°C had no statistically significant effect on the composition, LHV, CR, and pre- and post-filter tar and particulate contents of the syn-gas.
- Gas flow rates had significant effects on pre-filter tar and particulate concentrations, with particulate concentrations being significantly different between gas flow rates of 36 and 56 Nm³/h, and tar concentrations being significantly higher at 46 than at 36 and at 56 Nm³/h.
- Gas flow rates had no significant effect on the composition, LHV, CR, and post-filter tar and particulate concentrations of syn-gas.
- Bio-fuel MC significantly affected the CO content and tar content in post-filter syn-gas. As bio-fuel MC increased, the CO content significantly decreased, while the tar content significantly increased.
- Bio-fuel MC did not significantly affect the CR of hardwood chips or the particulate concentrations in pre- and post-filter syn-gas.

6.2 Suggestions for Future Research

- More species of bio-fuels should be tested to examine the breadth of feasibility and suitability of the RFGG.

- Proper grates should be designed for gasifying various bio-fuels.
- The control system and structure of the RFGG should be modified for controlling air ratio and temperature profile of the gasifier to optimize performance.
- Data collection conditions and measurement accuracy should be improved, such as by using a gas chromatograph (GC) for analyzing composition of syn-gas.
- Computer or mathematical simulations are recommended for use in the future studies, so that a better understanding of the RFGG's responsiveness to various conditions can be gained.

REFERENCES

- Abatzoglou, N., N. Barker, P. Hasler and H. Knoef. 2000. The development of a draft protocol for the sampling and analysis of particulate and organic contaminants in the gas from small biomass gasifiers. *Biomass Bioenergy* 18: 5-17.
- Babu, B.V., and A. S. Chaurasia. 2003. Modeling, simulation and estimation of optimum parameters in pyrolysis of biomass. *Energy Conversion Mgmt.* 44(13): 2135-2158.
- Chen (a), G., J. Andries, Z. Luo and H. Spliethoff. 2003. Biomass pyrolysis /gasification for product gas: the overall investigation of parametric effects. *Energy Conversion Mgmt.* 44(11): 1875-1884.
- Chen (b), G., J. Andries, and H. Spliethoff. 2003. Catalytic pyrolysis of biomass for hydrogen rich fuel gas production. *Energy Conversion Mgmt.* 44(14): 2289-2296.
- CPC, 2003. Biomax Renewable Fuel Gas Generator Manual. Community Power Corporation, Littleton, Colorado, U.S.
- Deglise, X. and P. Magne. 1987. Pyrolysis and industrial charcoal. *Biomass: Regenerable Energy*, 221-235. John Wiley and Sons, London.
- Devi, L., J. Krzysztof, J. Ptasinski, J. Frans and G. Janssen. 2003. A review of the primary measures for tar elimination in biomass gasification process. *Biomass Bioenergy* 24: 125-140.
- DOE. 2004. Bio-energy: an overview. U.S. Dept. of Energy, website: <http://www.eere.energy.gov/consumerinfo/factsheets/nb2.html>. Accessed on 8/15/2004.
- DOE. 2005. Biomass resources. U.S. Dept. of Energy, website: http://www.eere.energy.gov/RE/bio_resources.html. Accessed on 1/15/2005.

- Eurkela, E. and P. Stahlberg. 1992. Air gasification of peat wood and brown coal in a pressurized fluidized bed reactor:I. Carbon conversion, gas yields and tar formation. *Fuel Proc. Tech.*31: 1-21.
- FAO (Food and Agriculture Organization). 1986. Document: Wood gas as engine fuel. Forest Industries Division, Food and Agriculture Organization, United Nations, 00100 Rome, Italy.
- Fredriksson, C. 1999. Exploratory experimental and theoretical studies of cyclone gasification of wood powder. Ph.D. Dissertation, ISSN: 1402-1544. Department of Mechanical Engineering, Lulea University of Technology, Lulea, Sweden.
- Gil, J., and J. Corella. 1999. Biomass gasification in thermospheric and bubbling fluidized bed: effect of type of gasifying agent on the product distribution. *Biomass Bioenergy* 17: 389-403.
- Grabowski, P. 2001. Biopower research and development. Presentation paper at bioenergy Feedstock Development Program Contractor's Meeting, Memphis, Tennessee, U.S.
- Graham, R.G., and R. Bain, 1993. Biomass Gasification: Hot Gas Clean-up. Report Submitted to IEA Biomass Gasification Working Group, Ensyn Technologies/NREL, 44. National Renewable Energy Laboratory, U.S. Dept. of Energy, Golden, CO 80401, U.S.
- Hall, D.O., T.B. Johansson, H. Kelly, A.K.N. Reddy and R.H. Williams. 1992. Renewable energy - sources for fuels and electricity. Island Press, Earthscan, London.
- Hallgren, A. 1997. Improved technologies for the gasification of energy crops. Final report of project # JOR 3-CT97-0125, 3-12. European Commission JOULE 3 Program, Brussels, Belgium.
- Heesch, E.J.M., A.J. Pemen, M. Keping, S.V.B Yan, S.V.B. Paasen, and K.J. Ptasinski. 1999. Experimental program of the pulsed corona tar cracker. In: Proc. 12th IEEE Int Pulsed Power Conf. IEEE, New York.
- Hislop, D. and O. Hall. 1996. Biomass resources for gasification power plant. Report ETSU B/M3/00388/31/REP. University of London, King College, London.
- Jayah, T.H., and L. Aye. 2003. Computer simulation of a downdraft wood gasifier for tea drying. *Biomass Bioenergy* 25: 459-469.

- Klein, A. 2002. Gasification: an alternative process for energy recovery and disposal of municipal solid wastes. Master's Thesis, Department of Environmental Engineering, Columbia University, New York.
- Knoef, H.A.M. 2000. Inventory of biomass gasifier manufacture and installation. Final report to European Commission on Research Contract DIS/1734/98-NL, European Commission, Brussels, Belgium.
- Li, X. 2002. Biomass gasification in a circulating fluidized bed. Ph.D. Dissertation, Dept. of Chemical and Biological Engineering, University of British Columbia, Canada.
- Maniatis, K. 2001. Progress in biomass gasification: an overview. Directorate General for Energy and Transport, European Commission, Brussels, Belgium.
- Maniatis, K., and A. A. C. M. Beenacker. 2000. Tar protocol, IEA bioenergy gasification task. Biomass Bioenergy 18: 1-4.
- Milne, T.A., R.J. Evans and N. Abatzoglou. 1998. Biomass gasifier "tars": their nature, formation, and conversion. Publication No. NREL/TP-570-25357. National Renewable Energy Laboratory, Golden, CO 80401, U.S.
- Nader, A. and Padban, N. 2001. "PFB Air Gasification of Biomass, Investigation of Product Formation and Problematic Issues Related to Ammonia, Tar and Alkali". 5th Biomass Conferences of America, Orlando, Florida, U.S.
- Narváez, I., A. Orío, M. P. Aznar and J. Corella. 1996. Biomass gasification with air in an atmospheric bubbling fluidized bed. Effect of six operational variables on the quality of the produced raw gas. Ind. Eng. Chem. Res. 35(7): 2110-2120.
- Neeft, J.P.A., Knoef, H.A.M., and Onaji, P., 1999. Behavior of Tars in Biomass Gasification Systems. NOVEM EWAB Program Report 9919, 70-75. Available from MHP Management Services, P.O. box 127, 3950 AC, Maarn, Netherlands.
- Petersen, R. 1985. Design and Analysis of Experiments, 20-120. Marcel Dekker, New York.
- Pletka, R., R. C. Brown, and J. Smeenk. 2001. Indirectly heated biomass gasification using a latent heat ballast – 1: experimental evaluations. Biomass Bioenergy 20(4): 237-325.
- Spliethoff, H. 2001. Status of biomass gasification for power production. IFRF Combustion Journal, November, Article Number 200109, 7-25.

- Stergarsek, A. 2004. Cleaning of syn-gas derived from waste and biomass gasification/pyrolysis for storage or direct use for electricity. Presentation at Workshop of Jožef Stefan Institute, Ljubljana, Slovenia:
- Stevens, D.J. 2001. Hot gas conditioning: recent progress with larger-scale biomass gasification system, update and summary of recent progress. NREL Publication RS-510-29952. National Renewable Energy Laboratory, Golden, CO 80401, U.S.
- Tatsiopoulos, I. and A.Tolis. 2003. Economic aspects of the cotton-stalk biomass logistics and comparison of supply chain methods. *Biomass Bioenergy* 23: 199-214.
- Tiedema, Weide and Dekker. 1983. Converting diesel engines to the use of gaseous fuels. *Producer Gas* 1982: 393-414. Beijer Institute, SE- 10405 Stockholm, Sweden.
- Tsamba, A. J. 2001. Biomass gasification for sustainable development. Dept of Chemical Engineering, University of Eduardo Mondlane, Maputo, Mozambique. Website: <http://exergy.se/goran/hig/ses/01/biomass/#Lior>. Accessed on 10/16/2004.
- Turare, C. 1997. Biomass gasification technology and utilization. Artes Institute, University of Flensburg, Germany, website: <http://members.tripod.com/~cturare/pro.htm>. Accessed on 08/15/2004.
- Van Den Aarsen, A.A., C.M. Beenackers and W.P.M. Van Swaaij. 1982. "Performance of a Rice-husk Fluidized Bed Pilot Plant Gasifier". 1st Int. Prod. Gas Conf., Colombo, Sri Lanka.
- Waldheim, L. and T. Nilsson. 2001. Heating value of gases from biomass gasification. Publication No. TPS-01/16, National Renewable Energy Laboratory, Golden, CO 80401, U.S.
- Walsh, M. E., R. L. Perlack, A. Turhollow, D. T. Ugarte, D. A. Becker, R. L. Graham, S. E. Slinsky, and D. E. Ray, 2000. Biomass feedstock availability in the United States; Oak Ridge National Laboratory, Oak Ridge, TN 37831, U.S.
- Wang, M. and S. Ding. 1994. A potential renewable energy resource development and utilization of biomass energy. Paper No. 9408. In: *Integrated Energy Systems in China, Part II*. Rome: FAO, Publications Division, 00100 Rome, Italy.
- Warnecke, R. 2000. Gasification of biomass: comparison of fixed-bed and fluidized-bed gasifier. *Biomass Bioenergy* 18: 489-497.
- Xu, B., Z. Luo, C. Wu, H. Huang, and X. Zhou. 1994. Circulating fluidized-bed gasifier for biomass. Paper No. 9407. In: *Integrated Energy Systems in China, Part II*. Rome: FAO, Publications Division, 00100 Rome, Italy.

APPENDIX A

PROCEDURE FOR TAR AND PARTICULATE
DETERMINATIONS

PROCEDURE FOR TAR AND PARTICULATE DETERMINATIONS

Written by

James P. Diebold
Community Power Corporation
8420S. Continental Divide Rd
Littleton, CO 880127

August 2003

Revised by

Lin Wei
Department of Agricultural and Biological Engineering
Mississippi State University

May 2005

A.1. Introduction

Since there is no common or well-developed measurement standard for determination of tars and particulates in syn-gas produced from biomass gasification, this method is a modification of the traditional tar and particulate sampling procedure (Diebold, 2003) that has previously evolved at Community Power Corporation (CPC), which is the manufacturer of RFGG system, and also refers to the Tar Guideline developed in Europe and North America (Neeft et al., 2001; Li, 2002; CNE, 2004). The present determination of tars and particulates in syn-gas is carried out in two steps: sampling and analyzing.

A.2. Syn-gas Sampling

WARNING- the syn-gas is harmful for your health and it may be explosive. The sample ports and the sample equipment shall be gas tight. The exhaust syn-gas from sampling shall be burned or conducted to the open air in a way so that no inconvenience arises.

Measurements are performed during stable and known operating conditions of the gasifier. The characteristic operating conditions (such as the reaction temperature, gas flow rate, fuel type) during the sampling are recorded.

A.2.1 Principles of Syn-gas Sampling

The principle of the test method is based on the discontinuous sampling of a gas stream containing tar (organic compounds) and particulates under iso-kinetic conditions.

In general, sampling of tar and particles is performed simultaneously. Two sets of samples will be taken for comparisons, one is pre-cleaned syn-gas, and another is post-filter syn-gas. The sampling procedures are described as following:

A.2.1.1 Method of Sampling Pre-cleaned Syn-gas

The equipment for sampling pre-cleaned syn-gas consists of an Ice-bath tank, a filter holder, a dryer unit, a vacuum pump, and a flow meter. Gas sampling stream is shown as Figure A1.

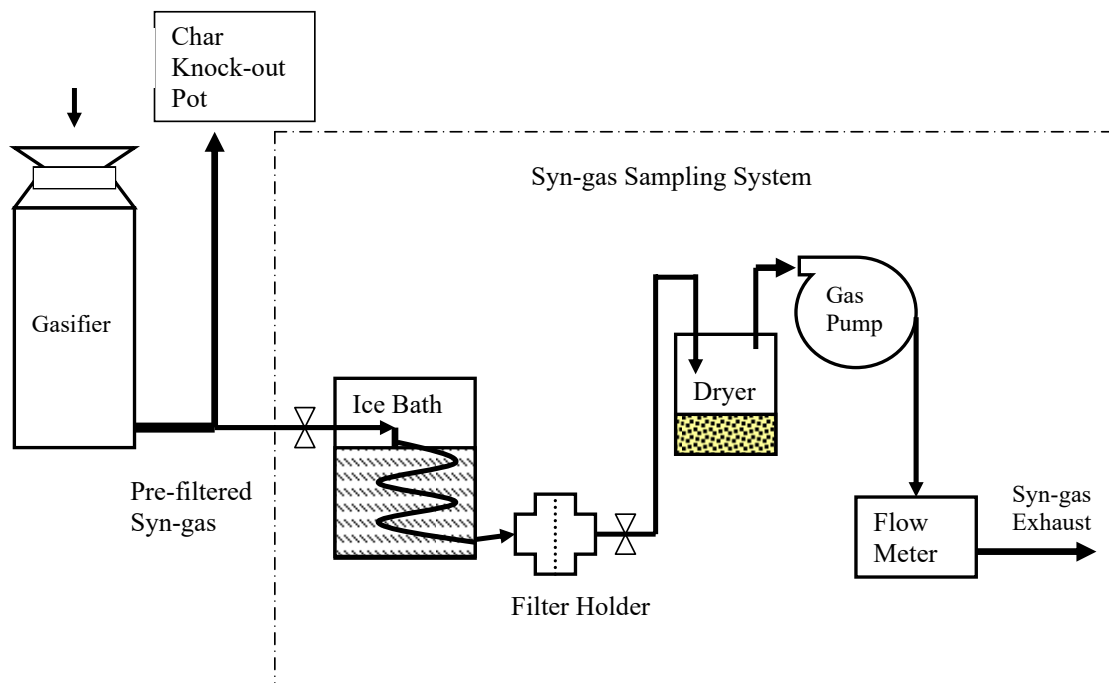

Figure A1: Flowchart of Pre-filtered Syn-gas Sampling

A.2.1.2 Method of Sampling Post-filtered Syn-gas

The equipment for sampling post-filter syn-gas consists of a filter holder, a dryer unit, a vacuum pump, and a flow meter. The gas sampling stream is as shown in Figure A2.

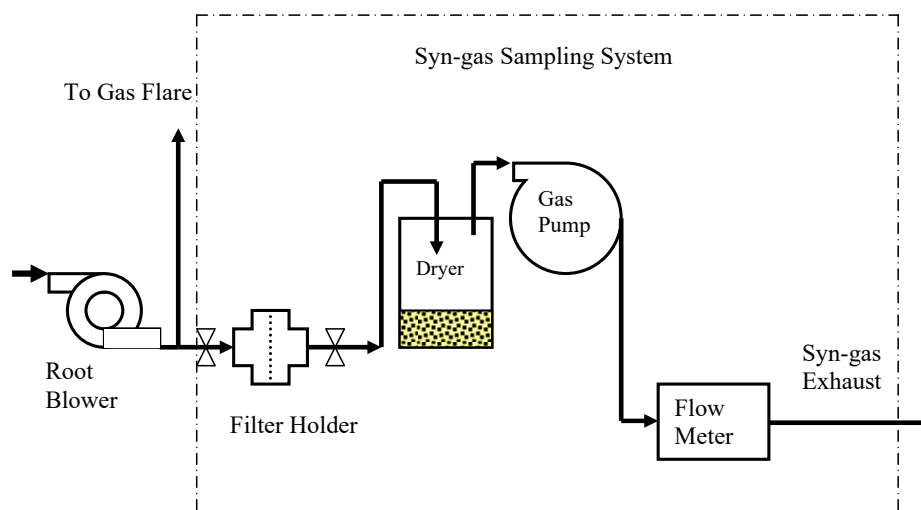

Figure A2: Flowchart of Post-filtered Syn-gas Sampling

A.2.2. Sampling Procedure

- Analytical scale calibration; Check that the ground wires are connected to the equipment; Turn on the analytical scale. Allow the balance to warm up for 20 minutes. Close the door to the weighing area. Then tare or zero the empty scale. Weigh the class 1 standard 150 g and 2 g weights. If the weights are not within 0.0001 g of 150.0000g or within 0.00002g of 2.00000g, then polish the weights with a clean paper towel and recalibrate the scale and re-weigh the standard weights. If the

standard weights are not available, recalibrate the scale at the start of each set of weighing.

- Wash the aluminum cups in acetone to remove any organic contaminants. Use rubber gloves and tweezers while handling the wet cups. Allow the cups to dry. To avoid contaminating the cups, do not touch the clean cups with bare hands.
- Wear clean cotton gloves and tweezers when handling the filter and clean cups. (New, clean rubber gloves may also be worn and used with the tweezers.) Remember that fingerprints and dirt will give erroneous tar and particulate values.
- Write the sample number on the tab and on the bottom of the aluminum cup, using a rounded point object. Use 47-mm diameter glass fiber filters No. 151 made by Ahlstrom, having a rating of 0.7 μm (VWP part 28496-176). Place the aluminum cup and clean filter in the oven at 68°C for at least 30 minutes to dry them. Allow the cup and the filter to cool to ambient temperature on a grounded metal plate before weighing, in order to obtain reproducible weights.
- Weigh the aluminum cup and the filter, using a grounded conductive glove. Weigh each cup and filter at least twice, or until the weight is reproducible within 0.00002g. Re-zero the balance between each weighing. Record the total weight in the Laboratory Notebook. Place the pre-weighed cup and filter in the covered plastic tray for safe keeping and to protect them from dust contamination.
- While in the clean analytical lab, place the weighed filter into the bottom of the filter holder, on the top of the screen support. (The bottom of the filter holder does not have

the small access port.) Record the filter number and tar sampler designation (e.g. A, or B) on the Tar Sampling Worksheet.

- Visually check the o-ring for cleanliness (remove any extraneous material). Install the o-ring onto the top of the filter holder (this half of the holder has the access port).
- Place the top of the filter holder on top of the filter and screw the ring by hand until it is tight. (The o-ring needs to be compressed for unit to be sealed.)
- Assemble the filter holder assembly to the corresponding helical tube heat exchanger.
- Check all tube fittings to be sure that they are also tight, check the bulkhead fitting nut. Install the sampling assembly onto the sample valve.
- Fill the Ice-tank with ice cubes. Add water to cover the ice cubes. Wait 5 minutes for coil to cool.
- Connect each sampling train to a vacuum pump and gas flow meter. Record in the Laboratory Notebook which meter will measure each gas flow.
- Open the bottom ball valves of the assemblies and turn on the vacuum pump. After a very short period, there should be no gas flowing through the gas meter. If there is gas flow, check all of the connections for tightness and also sample holder. Repeat with the other assembly. (Do not try to test both assemblies simultaneously, if they are interconnected, as this will show a leak). The system must be gas tight to avoid erroneously high measured gas flow.
- Write down the readings of each totalizer and the time.

- Open the high temperature valve at the top of the assembly.
- Turn on the vacuum pumps, using the power strip switch. When at least 2.5 ft³ (equal to around 70 L) of gas have passed through the totalizers (or when the gas flow rate has become very slow), turn off both pumps simultaneously with the power strip switch.
- Close both the high temperature valves at the top of the assembly and the ball-valve at the bottom of the assembly.
- Record the volumes of the syn-gas that passed through meters, the average temperature at the gas meter, average methane reading (if available), the ending time, and the local barometric pressure (www.Crh.noaa.gov) in the Laboratory Notebook. The spreadsheet corrects the barometric pressure for MSU'S elevation.
- Disconnect the sampling assembly from the sample valve and take it to analytical laboratory. Be careful not to spill the water on the hot equipment, as the resulting steam could hurt you. Dump the water in the sink.

A.2.3. Sample Analysis

Assume all tars and particulates were captured by the filters or condensed on the surfaces of sampling units, such as transport pipes, valves, or filter holders. These modifications are designed to take into account that tars and particulates have been condensing and sometimes re-evaporating in the transfer lines used to convey the sample to the filter. Also that tars could be depositing upstream of the sampling valve, if the

temperatures were much below 400°C. The sample analysis is to separate tars and particulates, and then determine the mass of them.

A.2.3.1 Principle of Sample Analysis

This procedure washes all tars and particulates from the transfer lines to the filters. The filter is still in the filter holder, so the particulates are left on the filter and the solvent (acetone) and tars in solution pass through into pre-weigh bottle. The filter and the particulates are dried in an oven held at about 68°C (normal boiling point of acetone is 56.5°C). The mass of particulates is measured after the filter cools down. The ultra-fine particulates and tars are determined as the residue left in bottle after the acetone is distilled off, using a boiling water bath. The acetone is recovered and used to clean up the tar residue from the bottle. The ultra-fine particulates are left on the inside wall of the sample bottle. The bottle is also dried in the oven held at about 68°C again. The mass of ultra-fine particulates is also determined after the bottle cools down. The wash acetone and tars are decanted to the waste acetone jug after soaking and swirling the sample bottle.

A.2.3.2 Analysis Procedures

- Install the sampling assembly on a ring stand in the analytical laboratory. Attach the CPI tee to the entrance of the helical coil.
- Use only the high purity acetone, which has less than 1 mg/L residue.
- Remove the pouring ring from the sample bottle, if new. Then pre-weigh the bottle with cap and record in Laboratory Notebook. Be sure to use the conductive glove to

handle the sample bottle, as this removes accumulated static electric charges, which interfere with the balance.

- Open ball valve and add acetone until it starts to run out of the bottom of the fixture. Close the bottom ball valve. Using the acetone squirt bottle, fill the sample holder with acetone. Add more acetone through the top of the helical coil. Allow to soak for 5 minutes and then open the ball-valve to drain the acetone and tars into a Pyrex bottle. Use an empty squirt bottle to gently force air through the sampling assembly.
- Rinse the apparatus three times, allowing the system to drain between rinses into the pre-weighed bottle. Use an empty squirt bottle to gently force air through the sampling assembly after each rinse. Use approximately 20 cc's of acetone for this first soak and 3 rinses.
- Using the acetone squirt bottle, add acetone into the helical coil assembly to fill it with acetone. Close the bottom ball-valve when acetone starts to drain out. Allow to soak for 5 minutes and then drain into the pre-weighed bottle. Use an empty squirt bottle to gently force air through the sampling assembly.
- Rinse at least 3 more times. Use an empty squirt bottle to force air through the sampling assembly after each rinse. Use approximately 20 cc's of acetone for this second soak and its rinses. Allow to drain completely after the last rinse.
- Screw the bottle with the tarry acetone into the distillation apparatus. Place a second bottle at the outlet of the helical coil to receive the acetone as it condenses.
- Add ice and water to the condenser can.

- Install the immersion heater in the can used for boiling water. Add water to the water bath to the “high” mark on the immersion heater. Plug in the heater.
- The acetone will distill from the bottle, condense in the cooled helical coil, and dribble into the receiving bottle.
- While the acetone is distilling, you will have about ten to fifteen minutes. Open the sample holder. Using tweezers transfer the dirty, wet filter with its particulates to its own pre-weighed cup. Transfer any of the filters that are stuck on the o-ring to the cup.
- Place the filter, particulates and the cup into the 68°C oven to dry. Dry for at least 60 minutes.
- Re-assemble the sample train in the clean analytical lab with a new pre-weighed filter and return it to the testing area. Place the pre-weighed aluminum cup in the covered plastic tray for safe keeping in the Analytical Lab.
- Meanwhile, after the acetone stops dribbling into the receiving bottle and the water bath heating the distillation has reached a roiling boil for at least 5 minutes, the distillation is complete.
- Unplug the immersion heater and remove it from the boiling water. Raise the distillation assembly and rotate it to remove the bottle from the boiling water. Immediately, unscrew the hot distilling bottle to relieve any negative pressure, so that any distilled acetone still in the condensing coil is not sucked back into the distilling

bottle. Wear clean cotton gloves or rubber gloves during this step to protect your hands from the hot surface and to prevent contamination by fingerprints.

- With a clean paper towel wipe dry the hot sample bottle.
- Place the hot bottle in the oven at 68°C for 30 minutes to insure that any residual moisture evaporates. After this final drying step, allow the bottle to cool near the exhaust fan for at least 15 minutes and then screw on that bottle's marked cap. Be sure to place the same pre-weighed cap on the same bottle to seal it. Allow the bottle to cool for another 45 minutes prior to weighing.
- Allow the filter, particulates, and cup to cool in a covered tray for at least 60 minutes before weighing.
- Weigh the residue, bottle, and cap. Also, weigh aluminum cup with the particulate and filter. Be sure to use the grounded, conductive glove while weighing and humidify the room if necessary to minimize static electricity.
- Add about 40 ml of the distilled acetone to the dirty sample bottle to cover the deposits on the wall and allow it to soak for at least 60 minutes. Gently swirl the acetone in the bottle. But do not attempt to remove the deposited ultra-fine particulates from the wall of the bottle. Decant the acetone and tars in solution. Using the acetone squirt bottle, gently rinse the residual tars from the distilling bottle into the solvent waste container. Try not to dislodge the ultra-fine particles from the wall of the bottle.

- Place the wet bottles with the deposit of ultra-fine particulates in the oven to dry for at least one hour. Allow the hot bottles to cool down one hour.
- Weigh the bottle and ultra-fine particulates. Record all weight data onto Laboratory Notebook.
- Place the used filter in the solid hazard zip-lock bag. Place the used aluminum cup in the trash.
- Wipe the inside of the bottle with a dry paper towel to remove the ultra-fine particulates.
- Clean all filter holders and bottles for next test.

A.3. Calculation of Results

The results can be calculated by using the following equations. The mass of particulates equals to the weight of particulates plus the weight of ultra-fine particulates. The mass of tars equals to the weight of tars and ultra-fine particulates minus the weight of ultra-fine particulates.

Tar concentration is defined as the total weight of tars per unit volume of syn-gas.

$$C_t = \frac{W_t}{V_g}$$

Where:

- C_t = the concentration of tar in syn-gas
 W_t = the weight of tar in syn-gas
 V_g = the volume of syn-gas

Particulate concentration is defined as the total weight of particulates per unit volume of syn-gas.

$$C_p = \frac{W_p}{V_g}$$

Where:

C_p	=	the concentration of particulates in syn-gas
W_p	=	the weight of particulates in syn-gas
V_g	=	the volume of syn-gas

A.4. References:

- Diebold, J. 2003. Procedure for tar and particulate determination. Community Power Corporation, Littleton, CO 80401, U.S.
- Li, X. 2002. Biomass gasification in a circulating fluidized bed. Ph.D. Dissertation. Dept. of Chemical and Biological Engineering, University of British Columbia, Canada.
- Codal, B., U. Zielke, M. Suomalainen, H.A.M. Knoef, J. Good, T. Liliedahl, C. Unger, L.Ventress, J.P.A. Neeft, H.W. v.d.Hoek1 and J.H.A. Kiel1, 2004. Tar measurement standard: a joint effort for the standardization of a method for measurement of tars and particulates in biomass producer gases. The 2nd World Conference and Technology Exhibition on Biomass for Energy, Industry and Climate Protection, Rome, Italy.

APPENDIX B

A TYPICAL DATAGRAPH RECORD FOR HARDWOOD CHIP GASIFICATION

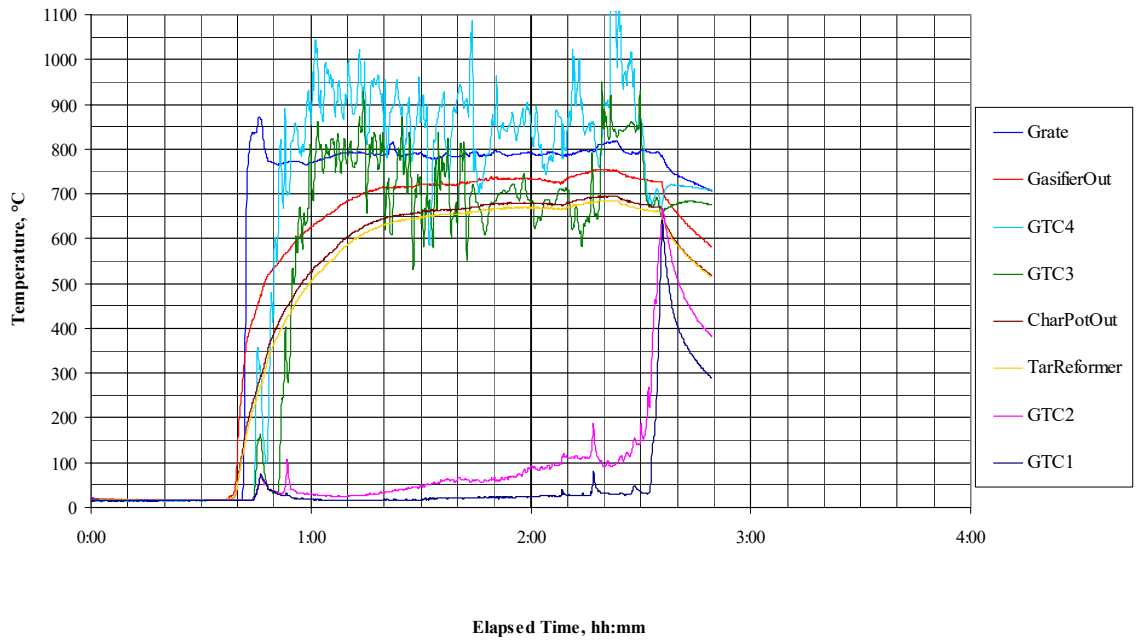

Figure B1: Temperatures of Gasifier During a Typical Test Run

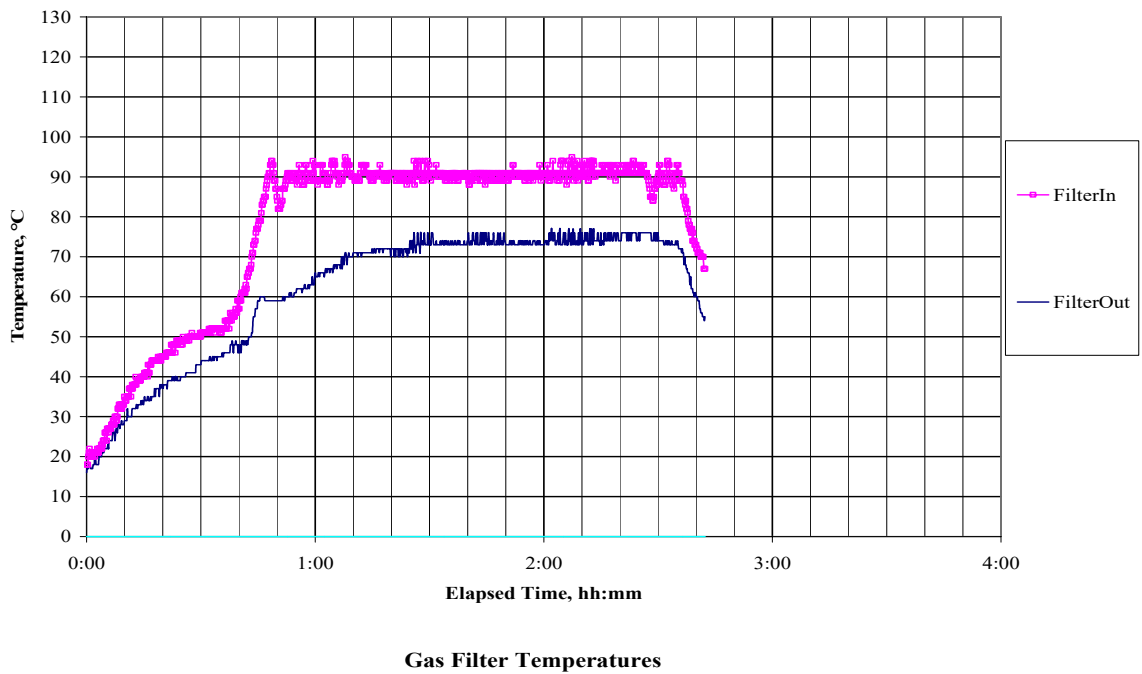

Figure B2: Bag Filter Temperatures of Gasifier During a Typical Test Run

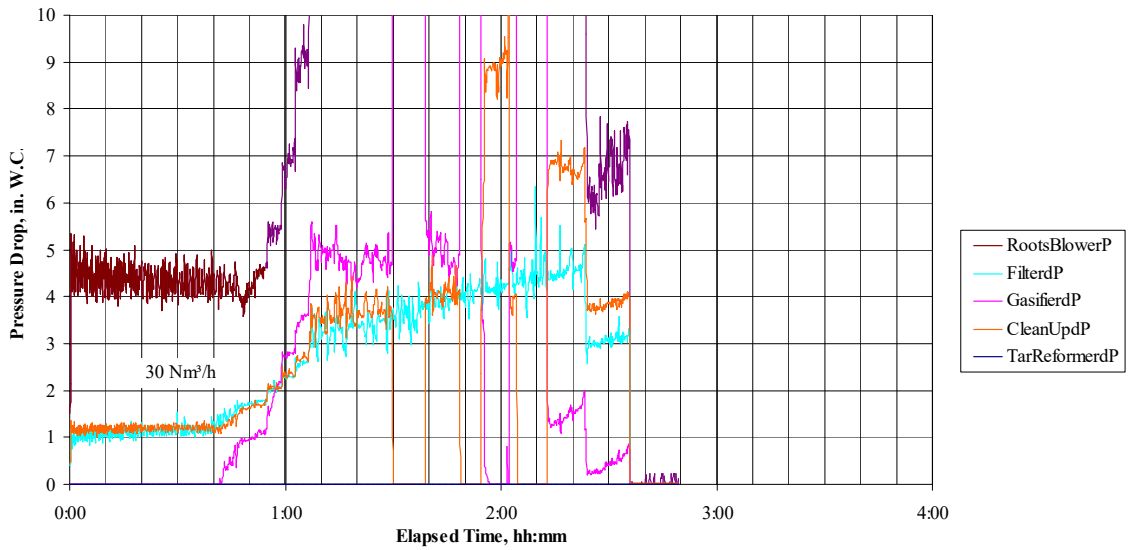

Figure B3: Pressure Drop in Gasifier System During a Typical Test Run

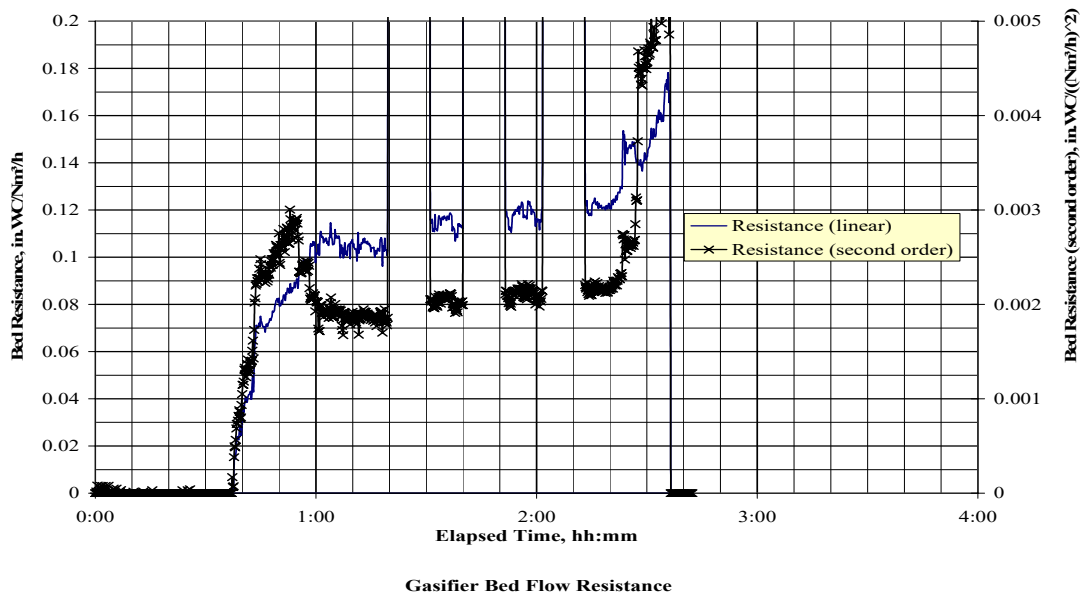

Figure B4: Gas Flow Resistance in Gasifier During a Typical Test Run

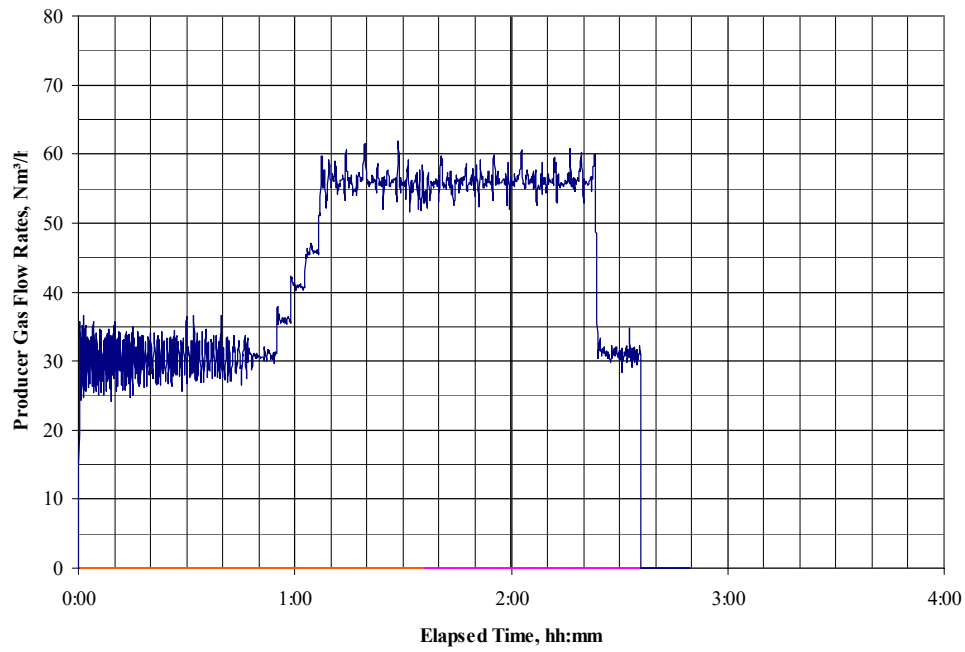

Figure B5: Gas Flow Rate of Gasifier During a Typical Test Run

APPENDIX C

ONE WAY ANOVA FOR THE EFFECTS OF GAS FLOW RATES

A total of 18 experimental runs, with six replications, for low (36 Nm³/h), medium (46 Nm³/h), and high gas flow rates (56 Nm³/h) were conducted to examine the effects of gas flow rate on syn-gas quality and bio-fuel CR. Data averages for each run are presented in Tables C1 through C3. A one-way ANOVA to consider the effects of gas flow rate was performed at the 95% confidence level with SAS software. The SAS programs are presented in Table C4. Results of the statistical analysis are presented in Tables C5 through C14.

Table C1: Compositions and Low Heating Values at Different Gas Flow Rates

Run No.	Gas flow rate Nm ³ /h	CO % (Vol.)	CH ₄ % (Vol.)	H ₂ % (Vol.)	CO ₂ % (Vol.)	LHV MJ/Nm ³
1	36.03	18.59	1.64	15.52	10.24	4.61
2	35.97	23.09	3.63	17.83	11.89	6.14
3	35.99	22.02	3.18	17.06	12.24	5.76
4	35.96	25.77	2.78	17.53	11.14	6.14
5	36.03	22.80	2.55	17.67	12.84	5.70
6	36.02	25.30	3.88	18.48	11.06	6.58
7	46.04	24.33	2.99	17.87	10.89	6.07
8	46.00	19.00	4.20	16.10	14.30	5.64
9	46.12	20.68	3.41	18.14	13.65	5.79
10	46.05	23.76	3.10	19.12	10.96	6.17
11	46.00	24.64	3.31	17.58	11.49	6.19
12	46.04	23.02	3.91	17.14	12.43	6.15
13	56.06	23.79	3.88	17.96	11.09	6.33
14	56.05	24.15	2.90	18.81	10.87	6.12
15	56.12	22.14	2.82	18.15	12.42	5.76
16	55.75	20.60	1.59	15.06	9.59	4.79
17	56.09	24.16	2.87	17.56	11.34	5.97
18	56.00	24.41	2.10	18.28	11.84	5.80

Table C2: Feeding Rates, Conversion Rates, and Residue Rates at Different Gas Flow Rates

Run No.	Gas flow rate Nm ³ /h	FR Kg/ h	CR Nm ³ /kg	RR %,Weight
1	36.03	19.08	2.63	1.10
2	35.97	21.31	2.16	1.03
3	35.99	20.45	2.38	0.58
4	35.96	20.25	2.45	0.88
5	36.03	17.30	2.51	0.82
6	36.02	21.63	2.05	1.33
7	46.04	19.86	2.59	0.79
8	46.00	22.69	2.25	0.76
9	46.12	22.73	2.19	0.93
10	46.05	20.58	2.48	1.42
11	46.00	21.13	2.57	1.27
12	46.04	23.33	2.38	2.69
13	56.06	25.68	2.38	1.26
14	56.05	24.73	2.38	0.95
15	56.12	24.80	2.33	1.92
16	55.75	23.78	2.53	0.54
17	56.09	23.81	2.52	0.88
18	56.00	23.36	2.70	0.72

Table C3: Tar and Particulate Concentrations at Different Gas Flow Rates

Run No.	Gas flow rate Nm ³ /h	pre-tar mg/Nm ³	pre-Particulate mg/Nm ³	post-tar mg/Nm ³	post-Particulate mg/Nm ³
1	36.03	44.73	51.03	16.88	3.90
2	35.97	38.80	74.40	24.99	1.77
3	35.99	47.03	41.16	18.70	1.74
4	35.96	30.61	85.36	11.02	1.04
5	36.03	21.48	65.89	17.04	4.39
6	36.02	41.66	74.89	4.94	1.57
7	46.04	43.11	123.93	5.51	1.67
8	46.00	60.40	73.32	10.44	1.39
9	46.12	64.29	44.57	10.36	3.33
10	46.05	72.09	96.25	7.44	8.00
11	46.00	89.33	111.30	9.25	0.99
12	46.04	53.85	154.27	9.68	1.03
13	56.06	50.98	201.43	5.44	4.18
14	56.05	52.10	109.60	6.60	4.05

Table C3 continued

15	56.12	34.67	120.86	12.96	4.13
16	55.75	57.87	68.57	16.05	4.07
17	56.09	32.24	108.76	27.80	2.14
18	56.00	77.08	72.83	13.33	3.22

Table C4: SAS Program for Analyzing the Effects of Gas Flow Rates

```

data input;
input trt $ Pre_part;
cards;
independent   Dependent
variables     variables
FR1
FR1
FR1
FR1
FR1
FR1
FR2
FR2
FR2
FR2
FR2
FR2
FR3
FR3
FR3
FR3
FR3
FR3
;
proc means sum mean css
std;
var Pre_part;
class trt;
ways 1;
run;
proc glm;
class trt;
model Pre_part=trt;
means trt/lsd lines;
run;

```

Table C5: ANOVA for Particulates in Pre-filtered Syn-gas at Different Gas Flow Rates

The MEANS Procedure
Analysis Variable : Pre_part

trt	Obs	Sum	Mean	Corrected SS	Std Dev
FR1	6	392.7300000	65.4550000	1363.76	16.5151939
FR2	6	603.6400000	100.6066667	7441.73	38.5790859
FR3	6	682.0500000	113.6750000	11496.10	47.9501870

The GLM Procedure
Class Level Information
Class Levels Values
trt 3 FR1 FR2 FR3
Number of observations 18

The GLM Procedure
Dependent Variable: Pre_part

Source	DF	Sum of Squares	Mean Square	F Value	Pr > F
Model	2	7463.17881	3731.58941	2.76	0.0956
Error	15	20301.58963	1353.43931		
Corrected Total	17	27764.76844			

R-Square 0.268800
Coeff Var 39.45402
Root MSE 36.78912
Pre_part Mean 93.24556

Source	DF	Type I SS	Mean Square	F Value	Pr > F
trt	2	7463.178811	3731.589406	2.76	0.0956
Source	DF	Type III SS	Mean Square	F Value	Pr > F
trt	2	7463.178811	3731.589406	2.76	0.0956

The GLM Procedure
t Tests (LSD) for Pre_part

NOTE: This test controls the Type I comparison wise error rate, not the experiment wise error rate.

Alpha 0.05
Error Degrees of Freedom 15
Error Mean Square 1353.439
Critical Value of t 2.13145
Least Significant Difference 45.272

Means with the same letter are not significantly different.

t Grouping	Mean	N	trt
A	113.68	6	FR3
A			
B A	100.61	6	FR2
B			
B	65.46	6	FR1

Table C6: ANOVA for Tars in Pre-filtered Syn-gas at Different Gas Flow Rates

The MEANS Procedure
Analysis Variable : Pre_tar

trt	N Obs	Sum	Mean	Corrected SS	Std Dev
FR1	6	224.3100000	37.3850000	466.1225500	9.6552840
FR2	6	383.0700000	63.8450000	1259.37	15.8705485
FR3	6	304.9400000	50.8233333	1346.99	16.4133661

The GLM Procedure
Class Level Information

Class	Levels	Values
trt	3	FR1 FR2 FR3

Number of observations 18
The GLM Procedure

Dependent Variable: Pre_tar

Source	DF	Sum of Squares	Mean Square	F Value	Pr > F
Model	2	2100.568411	1050.284206	5.13	0.0201
Error	15	3072.487033	204.832469		
Corrected Total	17	5173.055444			

	R-Square	Coeff Var	Root MSE	Pre_tar Mean
	0.406060	28.23740	14.31197	50.68444

Source	DF	Type I SS	Mean Square	F Value	Pr > F
trt	2	2100.568411	1050.284206	5.13	0.0201

Source	DF	Type III SS	Mean Square	F Value	Pr > F
trt	2	2100.568411	1050.284206	5.13	0.0201

The GLM Procedure
t Tests (LSD) for Pre_tar

NOTE: This test controls the Type I comparison wise error rate, not the experiment wise error rate.

Alpha	0.05
Error Degrees of Freedom	15
Error Mean Square	204.8325
Critical Value of t	2.13145
Least Significant Difference	17.612

Means with the same letter are not significantly different.

t Grouping	Mean	N	trt
A	63.845	6	FR2
A			
B A	50.823	6	FR3
B			
B	37.385	6	FR1

Table C7: ANOVA for Tars in Post-filtered Syn-gas at Different Gas Flow Rates

The MEANS Procedure
Analysis Variable : Post_tar

N					
trt	Obs	Sum	Mean	Corrected SS	Std Dev
FR1	6	93.5700000	15.5950000	236.1059500	6.8717676
FR2	6	52.6800000	8.7800000	18.7714000	1.9375964
FR3	6	82.1800000	13.6966667	323.6545333	8.0455520

The GLM Procedure
Class Level Information
Class Levels Values
trt 3 FR1 FR2 FR3
Number of observations 18

The GLM Procedure
Dependent Variable: Post_tar

Sum of					
Source	DF	Squares	Mean Square	F Value	Pr > F
Model	2	148.4430111	74.2215056	1.92	0.1803
Error	15	578.5318833	38.5687922		
Corrected Total	17	726.9748944			

R-Square Coeff Var Root MSE Post_tar Mean
0.204193 48.93700 6.210378 12.69056

Source	DF	Type I SS	Mean Square	F Value	Pr > F
trt	2	148.4430111	74.2215056	1.92	0.1803
Source	DF	Type III SS	Mean Square	F Value	Pr > F
trt	2	148.4430111	74.2215056	1.92	0.1803

The GLM Procedure
t Tests (LSD) for Post_tar

NOTE: This test controls the Type I comparison wise error rate, not the experiment wise error rate.

Alpha 0.05
Error Degrees of Freedom 15
Error Mean Square 38.56879
Critical Value of t 2.13145
Least Significant Difference 7.6424

Means with the same letter are not significantly different.

t Grouping	Mean	N	trt
A	15.595	6	FR1
A			
A	13.697	6	FR3
A			
A	8.780	6	FR2

Table C8: ANOVA for Particulates in Post-filtered Syn-gas at Different Gas Flow Rates

The MEANS Procedure
Analysis Variable : Post_part

trt	Obs	Sum	Mean	Corrected SS	Std Dev
FR1	6	14.4100000	2.4016667	9.5810833	1.3842748
FR2	6	16.4100000	2.7350000	36.9695500	2.7191745
FR3	6	21.7900000	3.6316667	3.3106833	0.8137178

The GLM Procedure
Class Level Information
Class Levels Values
trt 3 FR1 FR2 FR3
Number of observations 18

The GLM Procedure
Dependent Variable: Post_part

Source	DF	Squares	Mean Square	F Value	Pr > F
Model	2	4.85604444	2.42802222	0.73	0.4981
Error	15	49.86131667	3.32408778		
Corrected Total	17	54.71736111			

R-Square 0.088748
Coeff Var 62.37929
Root MSE 1.823208
Post_part Mean 2.922778

Source	DF	Type I SS	Mean Square	F Value	Pr > F
trt	2	4.85604444	2.42802222	0.73	0.4981
Source	DF	Type III SS	Mean Square	F Value	Pr > F
trt	2	4.85604444	2.42802222	0.73	0.4981

The GLM Procedure
t Tests (LSD) for Post_part

NOTE: This test controls the Type I comparison wise error rate, not the experiment wise error rate.

Alpha 0.05
Error Degrees of Freedom 15
Error Mean Square 3.324088
Critical Value of t 2.13145
Least Significant Difference 2.2436

Means with the same letter are not significantly different.

t Grouping	Mean	N	trt
A	3.632	6	FR3
A			
A	2.735	6	FR2
A			
A	2.402	6	FR1

Table C9: ANOVA for Low Heating Values of Post-filtered Syn-gas at Different Gas Flow Rates

The MEANS Procedure
Analysis Variable : LHV

trt	N	Sum	Mean	Corrected SS	Std Dev
FR1	6	34.9300000	5.8216667	2.2644833	0.6729760
FR2	6	36.0100000	6.0016667	0.2660833	0.2306874
FR3	6	34.7700000	5.7950000	1.4337500	0.5354904

Class Level Information

Class Levels Values
trt 3 FR1 FR2 FR3
Number of observations 18

The GLM Procedure

Dependent Variable: LHV

Source	DF	Sum of Squares	Mean Square	F Value	Pr > F
Model	2	0.15164444	0.07582222	0.29	0.7546
Error	15	3.96431667	0.26428778		
Corrected Total	17	4.11596111			

R-Square 0.036843
Coeff Var 8.753767
Root MSE 0.514089
LHV Mean 5.872778

Source	DF	Type I SS	Mean Square	F Value	Pr > F
trt	2	0.15164444	0.07582222	0.29	0.7546
Source	DF	Type III SS	Mean Square	F Value	Pr > F
trt	2	0.15164444	0.07582222	0.29	0.7546

The GLM Procedure

t Tests (LSD) for LHV

NOTE: This test controls the Type I comparison wise error rate, not the experiment wise error rate.

Alpha 0.05
Error Degrees of Freedom 15
Error Mean Square 0.264288
Critical Value of t 2.13145
Least Significant Difference 0.6326

Means with the same letter are not significantly different.

t Grouping	Mean	N	trt
A	6.0017	6	FR2
A			
A	5.8217	6	FR1
A			
A	5.7950	6	FR3

Table C10: ANOVA for CH₄ in Post-filtered Syn-gas at Different Gas Flow Rates

The MEANS Procedure
Analysis Variable : CH₄

N						
trt	Obs	Sum	Mean	Corrected SS	Std Dev	
FR1	6	17.6600000	2.9433333	3.2849333	0.8105471	
FR2	6	20.9200000	3.4866667	1.1213333	0.4735680	
FR3	6	16.1600000	2.6933333	3.0675333	0.7832667	

The GLM Procedure
Class Level Information
Class Levels Values
trt 3 FR1 FR2 FR3
Number of observations 18

The GLM Procedure
Dependent Variable: CH₄

Sum of						
Source	DF	Squares	Mean Square	F Value	Pr > F	
Model	2	1.97417778	0.98708889	1.98	0.1724	
Error	15	7.47380000	0.49825333			
Corrected Total	17	9.44797778				

R-Square Coeff Var Root MSE CH₄ Mean
0.208952 23.21094 0.705871 3.041111

Source	DF	Type I SS	Mean Square	F Value	Pr > F	
trt	2	1.97417778	0.98708889	1.98	0.1724	
Source	DF	Type III SS	Mean Square	F Value	Pr > F	
trt	2	1.97417778	0.98708889	1.98	0.1724	

The GLM Procedure
t Tests (LSD) for CH₄

NOTE: This test controls the Type I comparison wise error rate, not the experiment wise error rate.

Alpha 0.05
Error Degrees of Freedom 15
Error Mean Square 0.498253
Critical Value of t 2.13145
Least Significant Difference 0.8686

Means with the same letter are not significantly different.

t Grouping	Mean	N	trt
A	3.4867	6	FR2
A			
A	2.9433	6	FR1
A			
A	2.6933	6	FR3

Table C11: ANOVA for CO in Post-filtered Syn-gas at Different Gas Flow Rates

The MEANS Procedure
Analysis Variable : CO

N						
trt	Obs	Sum	Mean	Corrected SS	Std Dev	
FR1	6	137.5700000	22.9283333	33.3886833	2.5841317	
FR2	6	135.4300000	22.5716667	25.3180833	2.2502481	
FR3	6	139.2500000	23.2083333	11.5194833	1.5178592	

The GLM Procedure
Class Level Information
Class Levels Values
trt 3 FR1 FR2 FR3
Number of observations 18

The GLM Procedure
Dependent Variable: CO

Sum of					
Source	DF	Squares	Mean Square	F Value	Pr > F
Model	2	1.22191111	0.61095556	0.13	0.8786
Error	15	70.22625000	4.68175000		
Corrected Total	17	71.44816111			

R-Square 0.017102
Coeff Var 9.447479
Root MSE 2.163735
CO Mean 22.90278

Source	DF	Type I SS	Mean Square	F Value	Pr > F
trt	2	1.22191111	0.61095556	0.13	0.8786
Source	DF	Type III SS	Mean Square	F Value	Pr > F
trt	2	1.22191111	0.61095556	0.13	0.8786

The GLM Procedure
t Tests (LSD) for CO

NOTE: This test controls the Type I comparison wise error rate, not the experiment wise error rate.

Alpha 0.05
Error Degrees of Freedom 15
Error Mean Square 4.68175
Critical Value of t 2.13145
Least Significant Difference 2.6627

Means with the same letter are not significantly different.

t Grouping	Mean	N	trt
A	23.208	6	FR3
A			
A	22.928	6	FR1
A			
A	22.572	6	FR2

Table C12: ANOVA for CO₂ in Post-filtered Syn-gas at Different Gas Flow Rates

The MEANS Procedure
Analysis Variable : CO₂

N						
trt	Obs	Sum	Mean	Corrected SS	Std Dev	
FR1	6	69.4100000	11.5683333	4.3780833	0.9357439	
FR2	6	73.7200000	12.2866667	10.2781333	1.4337457	
FR3	6	67.1500000	11.1916667	4.6302833	0.9623184	

The GLM Procedure
Class Level Information
Class Levels Values
trt 3 FR1 FR2 FR3
Number of observations 18

The GLM Procedure
Dependent Variable: CO₂

Sum of					
Source	DF	Squares	Mean Square	F Value	Pr > F
Model	2	3.71381111	1.85690556	1.44	0.2669
Error	15	19.28650000	1.28576667		
Corrected Total	17	23.00031111			

R-Square Coeff Var Root MSE CO₂ Mean
0.161468 9.706343 1.133917 11.68222

Source	DF	Type I SS	Mean Square	F Value	Pr > F
trt	2	3.71381111	1.85690556	1.44	0.2669
Source	DF	Type III SS	Mean Square	F Value	Pr > F
trt	2	3.71381111	1.85690556	1.44	0.2669

The GLM Procedure
t Tests (LSD) for CO₂

NOTE: This test controls the Type I comparison wise error rate, not the experiment wise error rate.

Alpha 0.05
Error Degrees of Freedom 15
Error Mean Square 1.285767
Critical Value of t 2.13145
Least Significant Difference 1.3954

Means with the same letter are not significantly different.

t Grouping	Mean	N	trt
A	12.2867	6	FR2
A			
A	11.5683	6	FR1
A			
A	11.1917	6	FR3

Table C13: ANOVA for H₂ in Post-filtered Syn-gas at Different Gas Flow Rates

The MEANS Procedure
Analysis Variable : H₂

N					
trt	Obs	Sum	Mean	Corrected SS	Std Dev
FR1	6	104.0900000	17.3483333	5.0750833	1.0074804
FR2	6	105.9500000	17.6583333	5.1164833	1.0115813
FR3	6	105.8200000	17.6366667	8.8037333	1.3269313

The GLM Procedure
Class Level Information
Class Levels Values
trt 3 FR1 FR2 FR3
Number of observations 18

The GLM Procedure
Dependent Variable: H₂

Sum of					
Source	DF	Squares	Mean Square	F Value	Pr > F
Model	2	0.35941111	0.17970556	0.14	0.8689
Error	15	18.99530000	1.26635333		
Corrected Total	17	19.35471111			

R-Square 0.018570
Coeff Var 6.412913
Root MSE 1.125324
H₂ Mean 17.54778

Source	DF	Type I SS	Mean Square	F Value	Pr > F
trt	2	0.35941111	0.17970556	0.14	0.8689
Source	DF	Type III SS	Mean Square	F Value	Pr > F
trt	2	0.35941111	0.17970556	0.14	0.8689

The GLM Procedure
t Tests (LSD) for H₂

NOTE: This test controls the Type I comparison wise error rate, not the experiment wise error rate.

Alpha 0.05
Error Degrees of Freedom 15
Error Mean Square 1.266353
Critical Value of t 2.13145
Least Significant Difference 1.3848

Means with the same letter are not significantly different.

t Grouping	Mean	N	trt
A	17.6583	6	FR2
A			
A	17.6367	6	FR3
A			
A	17.3483	6	FR1

Table C14: ANOVA for Conversion Rates at Different Gas Flow Rates

The MEANS Procedure
Analysis Variable : CR

N					
trt	Obs	Sum	Mean	Corrected SS	Std Dev
FR1	6	14.1800000	2.3633333	0.2399333	0.2190586
FR2	6	14.4600000	2.4100000	0.1378000	0.1660120
FR3	6	14.8400000	2.4733333	0.0947333	0.1376469

The GLM Procedure
Class Level Information
Class Levels Values
trt 3 FR1 FR2 FR3
Number of observations 18

The GLM Procedure
Dependent Variable: CR

Sum of					
Source	DF	Squares	Mean Square	F Value	Pr > F
Model	2	0.03657778	0.01828889	0.58	0.5716
Error	15	0.47246667	0.03149778		
Corrected Total	17	0.50904444			

R-Square 0.071856
Coeff Var 7.347218
Root MSE 0.177476
CR Mean 2.415556

Source	DF	Type I SS	Mean Square	F Value	Pr > F
trt	2	0.03657778	0.01828889	0.58	0.5716
Source	DF	Type III SS	Mean Square	F Value	Pr > F
trt	2	0.03657778	0.01828889	0.58	0.5716

The GLM Procedure
t Tests (LSD) for CR

NOTE: This test controls the Type I comparison wise error rate, not the experiment wise error rate.

Alpha 0.05
Error Degrees of Freedom 15
Error Mean Square 0.031498
Critical Value of t 2.13145
Least Significant Difference 0.2184

Means with the same letter are not significantly different.

t Grouping	Mean	N	trt
A	2.4733	6	FR3
A			
A	2.4100	6	FR2
A			
A	2.3633	6	FR1

APPENDIX D

ONE WAY ANOVA FOR THE EFFECTS OF MOISTURE

CONTENTS

A total of 23 experimental runs, with six replications, for MC of hardwood chips at roughly 10, 12, 14, and 19% (wet basis) have been conducted to examine the effects of MC on syn-gas quality and bio-fuel CR. The results are presented in Tables D1 through D3. A one-way ANOVA was performed at the 95% confidence level with SAS software. The SAS program used is presented in Table D4. Details of the statistical analyses are presented in Table D5 through D15.

Table D1: Compositions and Low Heating Values at Different Moisture Contents

Run No.	MC% Actual	MC% Level	CO % (Vol.)	CH ₄ % (Vol.)	H ₂ % (Vol.)	CO ₂ % (Vol.)	LHV MJ/Nm ³
1	9.80	10	24.15	2.90	18.81	10.87	6.12
2	9.85	10	24.33	2.99	17.87	10.89	6.07
3	9.89	10	24.64	3.31	17.58	11.49	6.19
4	9.94	10	25.30	3.88	18.48	11.06	6.58
5	10.05	10	23.76	3.10	19.12	10.96	6.17
6	10.10	10	23.02	3.91	17.14	12.43	6.15
7	10.50	12	23.79	3.88	17.96	11.09	6.33
8	10.56	12	25.77	2.78	17.53	11.14	6.14
9	11.40	12	24.41	2.10	18.28	11.84	5.80
10	12.23	12	22.14	2.82	18.15	12.42	5.76
11	12.27	12	19.00	4.20	16.10	14.30	5.64
12	12.29	12	20.60	1.59	15.06	9.59	4.79
13	12.97	14	22.80	2.55	17.67	12.84	5.70
14	13.34	14	22.02	3.18	17.06	12.24	5.76
15	13.35	14	18.59	1.64	15.52	10.24	4.61
16	13.40	14	20.68	3.41	18.14	13.65	5.79
17	13.70	14	23.09	3.63	17.83	11.89	6.14
18	13.89	14	24.16	2.87	17.56	11.34	5.97
19	17.10	19	18.68	4.36	17.77	13.01	5.84
20	17.73	19	17.83	1.65	15.11	11.03	4.47
21	17.91	19	18.96	4.13	18.03	12.91	5.82
22	18.83	19	20.93	2.55	18.50	13.45	5.55
23	23.30	19	20.93	3.09	18.32	12.87	5.73

Table D2: Tars and Particulates in Syn-gas at Different Moisture Contents

	MC%	MC%	Pre-tar	Pre-particulate	Post-tar	Post-particulate
Run No.	Actual	Level	mg/Nm ³	mg/Nm ³	mg/Nm ³	mg/Nm ³
1	9.80	10	52.10	109.60	6.60	4.05
2	9.85	10	43.11	123.93	5.51	1.67
3	9.89	10	89.33	111.30	9.25	0.99
4	9.94	10	41.66	74.89	4.94	1.57
5	10.05	10	72.09	96.25	7.44	8.00
6	10.10	10	53.85	154.27	9.68	1.03
7	10.50	12	50.98	201.43	5.44	4.18
8	10.56	12	30.61	85.36	11.02	1.04
9	11.40	12	77.08	72.83	13.33	3.22
10	12.23	12	34.67	120.86	12.96	4.13
11	12.27	12	60.40	73.32	10.44	1.39
12	12.29	12	57.87	68.57	16.05	4.07
13	12.97	14	21.48	65.89	17.04	4.39
14	13.34	14	47.03	41.16	18.70	1.74
15	13.35	14	44.73	51.03	16.88	3.90
16	13.40	14	64.29	44.57	10.36	3.33
17	13.70	14	38.80	74.40	24.99	1.77
18	13.89	14	32.24	108.76	27.80	2.14
19	17.10	19	92.09	177.45	8.47	5.84
20	17.73	19	45.42	74.51	10.87	4.27
21	17.91	19	missing data		9.68	0.85
22	18.83	19	41.32	86.22	38.95	2.37
23	23.30	19	33.91	49.01	26.91	4.18

Table D3: Feeding Rate, Conversion Rate, and Residue Rate at Different Moisture Contents

Run No.	MC% Actual	MC% Level	FR Kg/ h	CR Nm ³ /kg	RR %, Weight
1	9.80	10	24.73	2.38	0.95
2	9.85	10	19.86	2.59	0.79
3	9.89	10	21.13	2.57	1.27
4	9.94	10	21.63	2.05	1.33
5	10.05	10	20.58	2.48	1.42
6	10.10	10	23.33	2.38	2.69
7	10.50	12	25.68	2.38	1.26
8	10.56	12	20.25	2.45	0.88
9	11.40	12	23.36	2.70	0.72
10	12.23	12	24.80	2.33	1.92
11	12.27	12	22.69	2.25	0.76
12	12.29	12	23.78	2.53	0.54
13	12.97	14	17.30	2.51	0.82
14	13.34	14	20.45	2.38	0.58
15	13.35	14	19.08	2.63	1.10
16	13.40	14	22.73	2.19	0.93
17	13.70	14	21.31	2.16	1.03
18	13.89	14	23.81	2.52	0.88
19	17.10	19	24.49	2.14	0.55
20	17.73	19	23.18	2.58	0.64
21	17.91	19	22.23	2.18	0.54
22	18.83	19	20.20	2.55	0.60
23	23.30	19	31.68	1.61	0.67

Table D4: SAS Program for Analyzing the Effects of Moisture Content

```

data input;
input trt $ Pre_part;
cards;
independent      Dependent
variables        variables
MC1
MC1
MC1
MC1
MC1
MC1
MC1
MC2
MC2
MC2
MC2
MC2
MC2
MC2
MC3
MC3
MC3
MC3
MC3
MC3
MC4
MC4
MC4
MC4
MC4
MC4
;
proc means sum mean css std;
var Pre_part;
class trt;
ways 1;
run;
proc glm;
class trt;
model Pre_part=trt;
means trt/lsd lines;
run;

```

Table D5: ANOVA for Low Heating Values of Syn-gas at Different Moisture Contents

The MEANS Procedure
Analysis Variable : LHV

trt	Obs	Sum	Mean	Corrected SS	Std Dev
mc1	6	37.2800000	6.2133333	0.1701333	0.1844632
mc2	6	34.4600000	5.7433333	1.4245333	0.5337665
mc3	6	33.9700000	5.6616667	1.4574833	0.5399043
mc4	5	27.4100000	5.4820000	1.3326800	0.5772088

The GLM Procedure
Class Levels Values
trt 4 mc1 mc2 mc3 mc4
Number of observations 23

The GLM Procedure
Dependent Variable: LHV

Sum of

Source	DF	Squares	Mean Square	F Value	Pr > F
Model	3	1.66136130	0.55378710	2.40	0.0997
Error	19	4.38483000	0.23078053		
Corrected Total	22	6.04619130			

R-Square Coeff Var Root MSE LHV Mean
0.274778 8.300115 0.480396 5.787826

Source	DF	Type I SS	Mean Square	F Value	Pr > F
trt	3	1.66136130	0.55378710	2.40	0.0997
Source	DF	Type III SS	Mean Square	F Value	Pr > F
trt	3	1.66136130	0.55378710	2.40	0.0997

t Tests (LSD) for LHV

Alpha 0.05
Error Degrees of Freedom 19
Error Mean Square 0.230781
Critical Value of t 2.09302
Least Significant Difference 0.5949
Harmonic Mean of Cell Sizes 5.714286

NOTE: Cell sizes are not equal.

Means with the same letter are not significantly different.

t Grouping	Mean	N	trt
A	6.2133	6	mc1
A			
B A	5.7433	6	mc2
B A			
B A	5.6617	6	mc3
B			
B	5.4820	5	mc4

Table D6: ANOVA for CO in Syn-gas at Different Moisture Contents

The MEANS Procedure
Analysis Variable : CO

trt	Obs	Sum	Mean	Corrected SS	Std Dev
MC1	6	145.2000000	24.2000000	3.0090000	0.7757577
MC2	6	135.7100000	22.6183333	31.9106833	2.5262891
MC3	6	131.3400000	21.8900000	19.7920000	1.9895728
MC4	5	97.3300000	19.4660000	7.8369200	1.3997250

The GLM Procedure
Class Level Information

Class	Levels	Values
trt	4	MC1 MC2 MC3 MC4
	Number of observations	23

The GLM Procedure
Dependent Variable: CO

Sum of

Source	DF	Squares	Mean Square	F Value	Pr > F
Model	3	62.9551619	20.9850540	6.37	0.0036
Error	19	62.5486033	3.2920318		
Corrected Total	22	125.5037652			

	R-Square	Coeff Var	Root MSE	CO Mean
	0.501620	8.189313	1.814396	22.15565

Source	DF	Type I SS	Mean Square	F Value	Pr > F
trt	3	62.95516188	20.98505396	6.37	0.0036

Source	DF	Type III SS	Mean Square	F Value	Pr > F
trt	3	62.95516188	20.98505396	6.37	0.0036

t Tests (LSD) for CO

NOTE: This test controls the Type I comparison wise error rate, not the experiment wise error rate.

Alpha	0.05
Error Degrees of Freedom	19
Error Mean Square	3.292032
Critical Value of t	2.09302
Least Significant Difference	2.2467
Harmonic Mean of Cell Sizes	5.714286

NOTE: Cell sizes are not equal.

Means with the same letter are not significantly different.

t Grouping	Mean	N	trt
A	24.200	6	MC1
A			
B A	22.618	6	MC2
B			
B	21.890	6	MC3
C	19.466	5	MC4

Table D7: ANOVA for CH₄ in Syn-gas at Different Moisture Contents

The MEANS Procedure
Analysis Variable : CH₄

trt	Obs	Sum	Mean	Corrected SS	Std Dev
MC1	6	20.0900000	3.3483333	0.9906833	0.4451255
MC2	6	17.3700000	2.8950000	5.0271500	1.0027113
MC3	6	17.2800000	2.8800000	2.5800000	0.7183314
MC4	5	15.7800000	3.1560000	5.0379200	1.1222656

The GLM Procedure
Class Level Information

Class	Levels	Values
trt	4	MC1 MC2 MC3 MC4
	Number of observations	23

The GLM Procedure
Dependent Variable: CH₄

Sum of

Source	DF	Squares	Mean Square	F Value	Pr > F
Model	3	0.90179449	0.30059816	0.42	0.7415
Error	19	13.63575333	0.71767123		
Corrected Total	22	14.53754783			

	R-Square	Coeff Var	Root MSE	CH ₄ Mean	
	0.062032	27.62984	0.847155	3.066087	
Source	DF	Type I SS	Mean Square	F Value	Pr > F
trt	3	0.90179449	0.30059816	0.42	0.7415
Source	DF	Type III SS	Mean Square	F Value	Pr > F
trt	3	0.90179449	0.30059816	0.42	0.7415

t Tests (LSD) for CH₄

NOTE: This test controls the Type I comparison wise error rate, not the experiment wise error rate.

Alpha	0.05
Error Degrees of Freedom	19
Error Mean Square	0.717671
Critical Value of t	2.09302
Least Significant Difference	1.049
Harmonic Mean of Cell Sizes	5.714286

NOTE: Cell sizes are not equal.

Means with the same letter are not significantly different.

t Grouping	Mean	N	trt
A	3.3483	6	MC1
A	3.1560	5	MC4
A			
A	2.8950	6	MC2
A			
A	2.8800	6	MC3

Table D8: ANOVA for H₂ in Syn-gas at Different Moisture Contents

The MEANS Procedure
Analysis Variable : H₂

trt	Obs	Sum	Mean	Corrected SS	Std Dev
MC1	6	109.0000000	18.1666667	2.9071333	0.7625134
MC2	6	103.0800000	17.1800000	8.5426000	1.3071037
MC3	6	103.7800000	17.2966667	4.4169333	0.9398865
MC4	5	87.7300000	17.5460000	7.7277200	1.3899388

The GLM Procedure
Class Level Information

Class	Levels	Values
trt	4	MC1 MC2 MC3 MC4
	Number of observations	23

The GLM Procedure
Dependent Variable: H₂

Sum of

Source	DF	Squares	Mean Square	F Value	Pr > F
Model	3	3.48805681	1.16268560	0.94	0.4426
Error	19	23.59438667	1.24180982		
Corrected Total	22	27.08244348			

	R-Square	Coeff Var	Root MSE	H ₂ Mean	
	0.128794	6.350603	1.114365	17.54739	
Source	DF	Type I SS	Mean Square	F Value	Pr > F
trt	3	3.48805681	1.16268560	0.94	0.4426
Source	DF	Type III SS	Mean Square	F Value	Pr > F
trt	3	3.48805681	1.16268560	0.94	0.4426

The GLM Procedure
t Tests (LSD) for H₂

NOTE: This test controls the Type I comparison wise error rate, not the experiment wise error rate.

Alpha	0.05
Error Degrees of Freedom	19
Error Mean Square	1.24181
Critical Value of t	2.09302
Least Significant Difference	1.3799
Harmonic Mean of Cell Sizes	5.714286

NOTE: Cell sizes are not equal.

Means with the same letter are not significantly different.

t Grouping	Mean	N	trt
A	18.1667	6	MC1
A	17.5460	5	MC4
A	17.2967	6	MC3
A			
A	17.1800	6	MC2

Table D9: ANOVA for CO₂ in Syn-gas at Different Moisture Contents

The MEANS Procedure
Analysis Variable : CO₂

trt	Obs	Sum	Mean	Corrected SS	Std Dev
MC1	6	67.7000000	11.2833333	1.8375333	0.6062233
MC2	6	70.3800000	11.7300000	12.4304000	1.5767308
MC3	6	72.2000000	12.0333333	7.0243333	1.1852707
MC4	5	63.2700000	12.6540000	3.5099200	0.9367390

The GLM Procedure
Class Level Information

Class	Levels	Values
trt	4	MC1 MC2 MC3 MC4

Number of observations 23

The GLM Procedure
Dependent Variable: CO₂

Sum of

Source	DF	Squares	Mean Square	F Value	Pr > F
Model	3	5.40333507	1.80111169	1.38	0.2793
Error	19	24.80218667	1.30537825		
Corrected Total	22	30.20552174			

	R-Square	Coeff Var	Root MSE	CO ₂ Mean	
	0.178886	9.606370	1.142532	11.89348	
Source	DF	Type I SS	Mean Square	F Value	Pr > F
trt	3	5.40333507	1.80111169	1.38	0.2793
Source	DF	Type III SS	Mean Square	F Value	Pr > F
trt	3	5.40333507	1.80111169	1.38	0.2793

The GLM Procedure
t Tests (LSD) for CO₂

NOTE: This test controls the Type I comparison wise error rate, not the experiment wise error rate.

Alpha	0.05
Error Degrees of Freedom	19
Error Mean Square	1.305378
Critical Value of t	2.09302
Least Significant Difference	1.4147
Harmonic Mean of Cell Sizes	5.714286

NOTE: Cell sizes are not equal.

Means with the same letter are not significantly different.

t Grouping	Mean	N	trt
A	12.6540	5	MC4
A	12.0333	6	MC3
A			
A	11.7300	6	MC2
A	11.2833	6	MC1

Table D10: ANOVA for Conversion Rates at Different Moisture Contents

The MEANS Procedure					
Analysis Variable : CR					
trt	Obs	Sum	Mean	Corrected SS	Std Dev
FR1	6	14.1800000	2.3633333	0.2399333	0.2190586
FR2	6	14.4600000	2.4100000	0.1378000	0.1660120
FR3	6	14.8400000	2.4733333	0.0947333	0.1376469
The GLM Procedure					
Class Level Information					
Class	Levels	Values			
trt	3	FR1	FR2	FR3	
Number of observations				18	
The GLM Procedure					
Dependent Variable: CR					
Source	DF	Sum of Squares	Mean Square	F Value	Pr > F
Model	2	0.03657778	0.01828889	0.58	0.5716
Error	15	0.47246667	0.03149778		
Corrected Total	17	0.50904444			
	R-Square	Coeff Var	Root MSE	CR Mean	
	0.071856	7.347218	0.177476	2.415556	
Source	DF	Type I SS	Mean Square	F Value	Pr > F
trt	2	0.03657778	0.01828889	0.58	0.5716
Source	DF	Type III SS	Mean Square	F Value	Pr > F
trt	2	0.03657778	0.01828889	0.58	0.5716
The GLM Procedure					
t Tests (LSD) for CR					
NOTE: This test controls the Type I comparison wise error rate, not the experiment wise error rate.					
Alpha		0.05			
Error Degrees of Freedom		15			
Error Mean Square		0.031498			
Critical Value of t		2.13145			
Least Significant Difference		0.2184			
Means with the same letter are not significantly different.					
t Grouping	Mean	N	trt		
A	2.4733	6	FR3		
A	2.4100	6	FR2		
A	2.3633	6	FR1		

Table D11: ANOVA for Tars in Pre-filtered Syn-gas at Different Moisture Contents

The MEANS Procedure
Analysis Variable : pre tar

trt	Obs	Sum	Mean	Corrected SS	Std Dev
MC1	6	352.1400000	58.6900000	1717.98	18.5363459
MC2	6	311.6100000	51.9350000	1492.90	17.2794638
MC3	6	248.5700000	41.4283333	1054.21	14.5203656
MC4	4	212.7400000	53.1850000	2086.20	26.3704260

The GLM Procedure
Class Level Information
Class Levels Values
trt 4 MC1 MC2 MC3 MC4
Number of observations 22

The GLM Procedure

Dependent Variable: pre_tar

Sum of					
Source	DF	Squares	Mean Square	F Value	Pr > F
Model	3	928.434048	309.478016	0.88	0.4714
Error	18	6351.283133	352.849063		
Corrected Total	21	7279.717182			

	R-Square	Coeff Var	Root MSE	pre_tar Mean		
	0.127537	36.73174	18.78428	51.13909		
Source	DF	Type I SS	Mean Square	F Value	Pr > F	
trt	3	928.4340485	309.4780162	0.88	0.4714	
Source	DF	Type III SS	Mean Square	F Value	Pr > F	
trt	3	928.4340485	309.4780162	0.88	0.4714	

The GLM Procedure

t Tests (LSD) for pre_tar

NOTE: This test controls the Type I comparison wise error rate, not the experiment wise error rate.

Alpha	0.05
Error Degrees of Freedom	18
Error Mean Square	352.8491
Critical Value of t	2.10092
Least Significant Difference	24.167
Harmonic Mean of Cell Sizes	5.333333

NOTE: Cell sizes are not equal.

Means with the same letter are not significantly different.

t Grouping	Mean	N	trt
A	58.69	6	MC1
A	53.19	4	MC4
A	51.94	6	MC2
A			
A	41.43	6	MC3

Table D12: ANOVA for Particulates in Pre-filtered Syn-gas at Different Moisture Contents

The MEANS Procedure
Analysis Variable : pre_part

trt	Obs	Sum	Mean	Corrected SS	Std Dev
MC1	6	670.2400000	111.7066667	3560.03	26.6834261
MC2	6	622.3700000	103.7283333	13291.99	51.5596499
MC3	6	385.8100000	64.3016667	3182.06	25.2271880
MC4	4	387.1900000	96.7975000	9397.09	55.9675116

Class Level Information

Class	Levels	Values
trt	4	MC1 MC2 MC3 MC4
	Number of observations	22

The GLM Procedure

Dependent Variable: pre_part

Sum of					
Source	DF	Squares	Mean Square	F Value	Pr > F
Model	3	7771.98948	2590.66316	1.58	0.2279
Error	18	29431.15578	1635.06421		
Corrected Total	21	37203.14526			

R-Square	0.208907
Coeff Var	43.06672
Root MSE	40.43593
pre_part Mean	93.89136

Source	DF	Type I SS	Mean Square	F Value	Pr > F
trt	3	7771.989484	2590.663161	1.58	0.2279
Source	DF	Type III SS	Mean Square	F Value	Pr > F
trt	3	7771.989484	2590.663161	1.58	0.2279

The GLM Procedure

t Tests (LSD) for pre_part

NOTE: This test controls the Type I comparisonwise error rate, not the experimentwise error rate.

Alpha	0.05
Error Degrees of Freedom	18
Error Mean Square	1635.064
Critical Value of t	2.10092
Least Significant Difference	52.023
Harmonic Mean of Cell Sizes	5.333333

NOTE: Cell sizes are not equal.

Means with the same letter are not significantly different.

t Grouping	Mean	N	trt
A	111.71	6	MC1
A	103.73	6	MC2
A	96.80	4	MC4
A			
A	64.30	6	MC3

Table D13: ANOVA for Tars in Post-filtered Syn-gas at Different Moisture Contents

The MEANS Procedure
Analysis Variable : post_tar

trt	Obs	Sum	Mean	Corrected SS	Std Dev
MC1	6	43.4200000	7.2366667	18.7261333	1.9352588
MC2	6	69.2400000	11.5400000	64.2510000	3.5847176
MC3	6	115.7700000	19.2950000	195.8735500	6.2589704
MC4	5	94.8800000	18.9760000	724.4079200	13.4574136

The GLM Procedure
Class Level Information
Class Levels Values
trt 4 MC1 MC2 MC3 MC4
Number of observations 23

The GLM Procedure

Dependent Variable: post_tar

Sum of					
Source	DF	Squares	Mean Square	F Value	Pr > F
Model	3	602.716084	200.905361	3.80	0.0272
Error	19	1003.258603	52.803084		
Corrected Total	22	1605.974687			

	R-Square	Coeff Var	Root MSE	post_tar Mean		
	0.375296	51.69379	7.266573	14.05696		
Source	DF	Type I SS	Mean Square	F Value	Pr > F	
trt	3	602.7160836	200.9053612	3.80	0.0272	
Source	DF	Type III SS	Mean Square	F Value	Pr > F	
trt	3	602.7160836	200.9053612	3.80	0.0272	

The GLM Procedure

t Tests (LSD) for post_tar

NOTE: This test controls the Type I comparisonwise error rate, not the experimentwise error rate.

Alpha 0.05
Error Degrees of Freedom 19
Error Mean Square 52.80308
Critical Value of t 2.09302
Least Significant Difference 8.9978
Harmonic Mean of Cell Sizes 5.714286

NOTE: Cell sizes are not equal.

Means with the same letter are not significantly different.

t Grouping	Mean	N	trt
A	19.295	6	MC3
A	18.976	5	MC4
B A	11.540	6	MC2
B			
B	7.237	6	MC1

Table D14: ANOVA for Particulates in Post-filtered Syn-gas at Different Moisture Contents

The MEANS Procedure
Analysis Variable : post_part

trt	Obs	Sum	Mean	Corrected SS	Std Dev
MC1	6	17.3100000	2.8850000	37.7579500	2.7480156
MC2	6	18.0300000	3.0050000	10.2961500	1.4350017
MC3	6	17.2700000	2.8783333	6.6022833	1.1491113
MC4	5	17.5100000	3.5020000	14.8302800	1.9255051

Class Level Information

Class	Levels	Values
trt	4	MC1 MC2 MC3 MC4
	Number of observations	23

The GLM Procedure

Dependent Variable: post_part

Sum of

Source	DF	Squares	Mean Square	F Value	Pr > F
Model	3	1.37379754	0.45793251	0.13	0.9440
Error	19	69.48666333	3.65719281		
Corrected Total	22	70.86046087			

R-Square	Coeff Var	Root MSE	post_part Mean
0.019387	62.72777	1.912379	3.048696

Source	DF	Type I SS	Mean Square	F Value	Pr > F
trt	3	1.37379754	0.45793251	0.13	0.9440

Source	DF	Type III SS	Mean Square	F Value	Pr > F
trt	3	1.37379754	0.45793251	0.13	0.9440

The GLM Procedure

t Tests (LSD) for post_part

NOTE: This test controls the Type I comparisonwise error rate, not the experimentwise error rate.

Alpha	0.05
Error Degrees of Freedom	19
Error Mean Square	3.657193
Critical Value of t	2.09302
Least Significant Difference	2.368
Harmonic Mean of Cell Sizes	5.714286

NOTE: Cell sizes are not equal.

Means with the same letter are not significantly different.

t Grouping	Mean	N	trt
A	3.502	5	MC4
A	3.005	6	MC2
A	2.885	6	MC1
A			
A	2.878	6	MC3

Table D15: ANOVA for Residue Rates at Different Moisture Contents

The MEANS Procedure
Analysis Variable : RR

trt	Obs	Sum	Mean	Corrected SS	Std Dev
MC1	6	8.4500000	1.4083333	2.2604833	0.6723813
MC2	6	6.0800000	1.0133333	1.2749333	0.5049620
MC3	6	5.3400000	0.8900000	0.1664000	0.1824281
MC4	5	3.0000000	0.6000000	0.0126000	0.0561249

The GLM Procedure
Class Level Information

Class	Levels	Values
trt	4	MC1 MC2 MC3 MC4
Number of observations		23

Dependent Variable: RR

Source	DF	Sum of Squares	Mean Square	F Value	Pr > F
Model	3	1.87334855	0.62444952	3.19	0.0470
Error	19	3.71441667	0.19549561		
Corrected Total	22	5.58776522			
	R-Square	Coeff Var	Root MSE	RR Mean	
	0.335259	44.46622	0.442149	0.994348	
Source	DF	Type I SS	Mean Square	F Value	Pr > F
trt	3	1.87334855	0.62444952	3.19	0.0470
Source	DF	Type III SS	Mean Square	F Value	Pr > F
trt	3	1.87334855	0.62444952	3.19	0.0470

t Tests (LSD) for RR

NOTE: This test controls the Type I comparison wise error rate, not the experiment wise error rate.

Alpha	0.05
Error Degrees of Freedom	19
Error Mean Square	0.195496
Critical Value of t	2.09302
Least Significant Difference	0.5475
Harmonic Mean of Cell Sizes	5.714286

NOTE: Cell sizes are not equal.

Means with the same letter are not significantly different.

t Grouping	Mean	N	trt
A	1.4083	6	MC1
B A	1.0133	6	MC2
B A			
B A	0.8900	6	MC3
B			
B	0.6000	5	MC4